

EAC-S (SP)

EAC-3S (SP)



Table of contents

1	Info & Contact Addresses	1
2	Technical Specifications	2
2.1	<i>Ambient Conditions</i>	2
2.2	<i>Input Specifications</i>	2
2.3	<i>Output Specifications</i>	3
2.4	<i>ATI-Interface</i>	4
2.5	<i>RS 232</i>	4
2.6	<i>RS 485</i>	4
3	Technical Drawing	5
4	Important Safety Instructions	9
4.1	<i>Initial Operation</i>	9
4.2	<i>Unpacking</i>	9
4.3	<i>Setting Up</i>	9
4.4	<i>Visual Inspection</i>	9
4.5	<i>Mains Operation</i>	9
5	Functional Description	10
5.1.1	<i>ATE-Version (Option ATE)</i>	10
5.1.2	<i>External Release (Option Interlock)</i>	10
5.1.3	<i>Output</i>	10
5.1.4	<i>Input</i>	11
6	General Settings	11
6.1	<i>Initial State</i>	11
6.2	<i>Configuration</i>	11
6.3	<i>Contrast</i>	11
7	Front Panel Operation	12
7.1	<i>Console and rotary pulse encoder</i>	12
7.2	<i>Displays and Settings</i>	13
7.2.1	<i>Actual measurements (display)</i>	13
7.2.2	<i>Displaying the preset data</i>	13
7.2.3	<i>Selecting the wave form</i>	13
7.2.4	<i>Setting the frequency</i>	13
7.2.5	<i>Adjusting the phase</i>	13
7.3	<i>Amplitude control</i>	14
7.3.1	<i>AC voltage</i>	14
7.3.2	<i>DC voltage</i>	15
7.4	<i>Limitation</i>	15
7.5	<i>Sync output (option)</i>	16
7.6	<i>Sync input (option)</i>	16
7.7	<i>Three-phase System (Option /3S)</i>	17
7.7.1	<i>Control</i>	17
7.7.2	<i>Activation/Deactivation</i>	17
7.8	<i>Programming of the wave form into the internal memory</i>	17
7.9	<i>MMC Direct</i>	17
7.10	<i>Error messages</i>	18
7.11	<i>Standby</i>	18
8	3-Phase-Sync-Function (Option)	18
9	External Oscillator: Ext Osz (Option)	19
10	External analog control: /AI5, /AI10 (Option)	19
10.1	<i>Pin assignment interface 1, Digital outputs</i>	19
10.2	<i>Pin assignment interface 2, Digital inputs</i>	19
10.3	<i>Pin assignment interface 3, analog in- and outputs</i>	21
10.4	<i>Connection examples</i>	22
10.4.1	<i>Single-phase device control</i>	22

10.4.2	Three-phase device control	22
11	External Control: Computer (Option)	23
11.1	<i>Universal interface (Option /RS232; RS485; USB; LAN; IEEE).....</i>	23
11.2	<i>Adjusting the 6way DIP switch</i>	23
11.3	<i>Commands</i>	23
11.3.1	Format	23
11.3.2	Reponse string	24
11.3.3	Instruction set.....	24
11.3.4	Overview of the commands.....	25
11.3.5	Full description of commands.....	28
12	External Control: GPIB (Option / IEEE)	43
12.1	<i>Status Word</i>	44
12.2	<i>SES-Register - Standard Event Status Register (SES)</i>	45
13	RS232 interface (Option)	45
14	RS485 interface (Option).....	47
14.1.1	Reconfiguration of the interface	47
15	External Control: Ethernet (LAN) (Option)	48
15.1	<i>Determinating the IP using the device installer by Lantronix.....</i>	49
15.2	<i>Controlling the device with telnet</i>	49
	<i>TELNET CONNECTION WITH REALTERM</i>	50
16	External Control: USB (option)	50
16.1.1	Reconfiguration of the interface	51
17	Data Log function (Option SD-CARD)	51
17.1	<i>Data format of the saved data.....</i>	52
18	Script Mode (Option SD-Card	52
18.1	<i>Executing/Loading a script.....</i>	52
18.2	<i>Commands</i>	53
18.2.1	Syntax	53
18.2.2	Quick view of commands.....	53
18.2.3	Detailed description of commands.....	55
19	Appendix	58
19.1	<i>Generating user-defined waves</i>	59
19.1.1	Introduction	59
19.1.2	Creating a .wav file	59
19.1.3	Creating a .wav file with SwitcherCAD (Linear Technology).....	59
19.1.4	Creating, editing and loading a .wav file with a wave editor.....	60
19.1.5	Creating a .wav file with macros.....	67
20	Notes	70

1 INFO & CONTACT ADDRESSES

ET System electronic GmbH was founded in 1986 in the heart of the Rhine-Neckar-Triangle. As a subsidiary of a leading electricity utility group, the company quickly took on a leading role in the area of laboratory power electronics and associated electrical measurement. The existing knowledge in power technologies in the 90s gave rise to the “Power Solutions” product division as a strong extension of the historical “Test & Measurement” range.

Since 1997, we have been working successfully as an independent, privately held company with customers in all lines of business from industry, medical care, railway technology and automotive electronics.

By means of our high vertical range of manufacture and our ever-expanding development division, we can adjust fast and flexibly to our customers’ requirements. Qualified personnel flexibly carry out necessary approvals such as CSA, UL, VDE, TÜV etc. The approval procedures are performed within the scope of development planning and thus do not negatively affect the start of manufacturing. Permanent manufacturing control through accredited laboratories and an ISO 9001 compliant quality management system guarantee a constant high-level series-production quality.

We offer repairs and adjustment for units outside of our warranty period. Please contact your local distributor for further information:

Deutschland

ET System electronic GmbH
Hauptstraße 119-121
68804 Altlußheim

GERMANY

Tel.: +49 (0) 6205 39480
Fax: +49 (0) 6205 37560

em@il: info@et-system.de

web: www.et-system.de

Place of Business: Altlußheim, Germany

VAT Identification Number: DE 144 285 482

Register Court: Mannheim, Germany

Register Number: HRB 421186

2 TECHNICAL SPECIFICATIONS

2.1 AMBIENT CONDITIONS

Cooling	Fan
Operating temperature	0 - 50 °C
Storage temperature	-20 - 70 °C
Humidity	< 80 %
Operating altitude	< 2000 m

2.2 INPUT SPECIFICATIONS

Version	EAC-S 250	EAC-S 500	EAC-S 1000	EAC-S 2000	EAC-S 3000	EAC-S 4000
Connection	3 wire (1P+N+PE)/ 4wire (2P+N+PE)/ 5wire (3P+N+PE)					
Input 1P/230 1 x 230 VAC (207 - 253 VAC, 47- 63 Hz)	X	X	X			
Input 2P/400 2 x 400 VAC (360 - 440 VAC, 47 - 63 Hz)				X	X	
Input 3P/208 3 x 208 VAC (187 - 228 VAC, 47 - 63 Hz) Option						
Input 3P/ 400 3 x 400 VAC (360 - 440 VAC, 47 - 63 Hz)						X
Input 3P/ 440 3 x 440 VAC (396 - 484 VAC, 47 - 63 Hz) Option						
Input 3P/ 480 3 x 480 VAC (432 - 528 VAC, 47 - 63 Hz) Option						
Max. allowed non symmetry	< 3 %	< 3 %	< 3 %	< 3 %	< 3 %	< 3 %
Nominal Current Internal Fuse	10 A	10 A	25 A	2 x 20 A	2 x 25 A	3 x 32 A
Automatic Circuit Breaker	K	K	K	K	K	K
Fuse Rating	16 A	16 A	32 A	2 x 25 A	2 x 32 A	3 x 40 A
Leakage Current	< 3.5 mA	< 3.5 mA	< 3.5 mA	< 3.5 mA	< 3.5 mA	< 30 mA
Cos phi	≥ 0.7	≥ 0.7	≥ 0.7	≥ 0.7	≥ 0.7	≥ 0.7
Efficiency Type	54 %	54 %	54 %	54 %	54 %	54 %
Weight	30 kg	33 kg	60 kg	83 kg	101 kg	239 kg

Version	EAC-S 5000	EAC-S 6000	EAC-S 7000	EAC-S 8000	EAC-S 9000	EAC-S 10000
Connection	3 wire (1P+N+PE)/ 4wire (2P+N+PE)/ 5wire (3P+N+PE)					
Input 1P/230 1 x 230 VAC (207 - 253 VAC, 47- 63 Hz)						
Input 2P/400 2 x 400 VAC (360 - 440 VAC, 47 - 63 Hz)						
Input 3P/208 3 x 208 VAC (187 - 228 VAC, 47 - 63 Hz) Option						
Input 3P/ 400 3 x 400 VAC (360 - 440 VAC, 47 - 63 Hz)	X	X	X	X	X	X
Input 3P/ 440 3 x 440 VAC (396 - 484 VAC, 47 - 63 Hz) Option						
Input 3P/ 480 3 x 480 VAC (432 - 528 VAC, 47 - 63 Hz) Option						
Max. allowed non symmetry	< 3 %	< 3 %	< 3 %	< 3 %	< 3 %	< 3 %
Nominal Current Internal Fuse	3 x 38 A	3 x 42 A	3 x 45 A	3 x 50 A	3 x 56 A	3 x 63 A
Automatic Circuit Breaker	K	K	K	K	K	K
Fuse Rating	3 x 40 A	3 x 50 A	3 x 50 A	3 x 63 A	3 x 63 A	3 x 63 A
Leakage Current	< 30 mA	< 30 mA	< 30 mA	< 30 mA	< 30 mA	< 30 mA
Cos phi	< 0.6	< 0.6	< 0.6	< 0.6	< 0.6	< 0.6
Efficiency Type	54%	54%	54%	54%	54%	54%
Weight	252 kg	264 kg	287 kg	363 kg	418 kg	437 kg

2.3 OUTPUT SPECIFICATIONS

Static voltage regulation	0.1 %
Static current regulation	0.1 %
Dynamic regulation	5 periods
Ripple	0.3 % at 50 Hz
Programming accuracy (U_a)	100 mV
Programming accuracy (I_a)	10 mA
Programming accuracy frequency	0.1 Hz
Programming accuracy activation phase	0.1°
Display accuracy (U_a)	0.1 % of total value
Display accuracy (I_a)	0.1 % of total value
Display accuracy frequency	0.1 % of total value
Isolation primary/ground	2150 VDC
Isolation output/ground	500 VDC
Isolation primary/secondary	3000 VDC
Protection devices	OT/OP

2.4 ATI-INTERFACE

Digital outputs (CV, Standby, Error)	Output type: Open collector with pull-up resistor 10 k after + 5 V I_{sinkmax} : 50 mA
Digital inputs (Ext. Control, Standby)	Input resistance: 47 k Ω Maximum input voltage: 50 V High level: $U_e > 2 \text{ V}$ Low level: $U_e < 0.8 \text{ V}$
Analog outputs (X_{mon})	Output resistance: 100 Ω Minimum permissible load resistance: 2 k Ω Minimum load resistance for 0.1 % accuracy: 100 k Ω
Analog inputs (X_{set})	Input resistance: 1 M Ω Maximum permissible input voltage: 25 V
Reference voltage	Reference voltage U_{ref} : 10 V \pm 10 mV Output resistance: < 10 Ω Maximum output current: 10 mA (not short-circuit proof)
5 V - Supply voltage	Output voltage: 5 V \pm 300 mV Maximum output current: 50 mA (not short-circuit-proof)

2.5 RS 232

Signal inputs (RxD, CTS)	Maximum input voltage: $\pm 25 \text{ V}$ Input resistance: 5 k Ω (Type) Switching thresholds: $U_H < - 3 \text{ V}$, $U_L > + 3 \text{ V}$
Signal outputs(TxD, RTS)	Output voltage (at $R_{\text{Last}} > 3 \text{ k}\Omega$): min $\pm 5 \text{ V}$, Type $\pm 9 \text{ V}$, max $\pm 10 \text{ V}$ Output resistance: < 300 Ω Short circuit current: Type $\pm 10 \text{ mA}$

2.6 RS 485

Maximum input voltage	$\pm 5 \text{ V}$
Input resistance	> 12 k Ω
Output current	$\pm 60 \text{ mA Max}$
High level	$U_d > 0.2 \text{ V}$
Low level	$U_d > - 0.2 \text{ V}$

3 TECHNICAL DRAWING

EAC-S 250, EAC-S 500

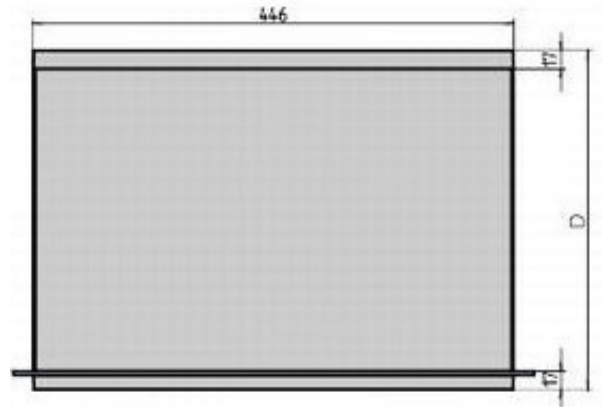
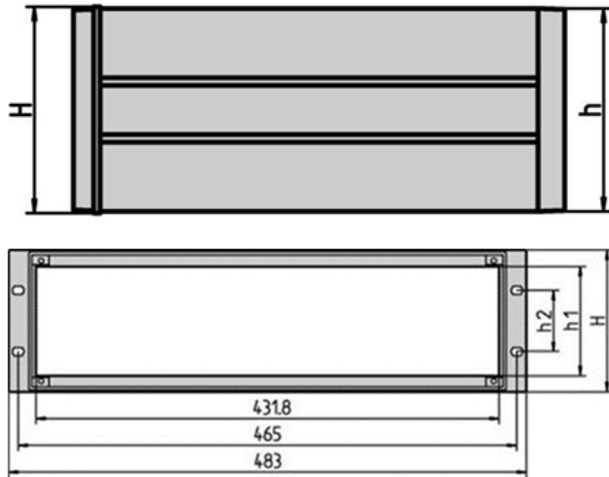

$H = 4HE, D = 434.5 \text{ mm}$

EAC-S 1000, EAC-S 2000

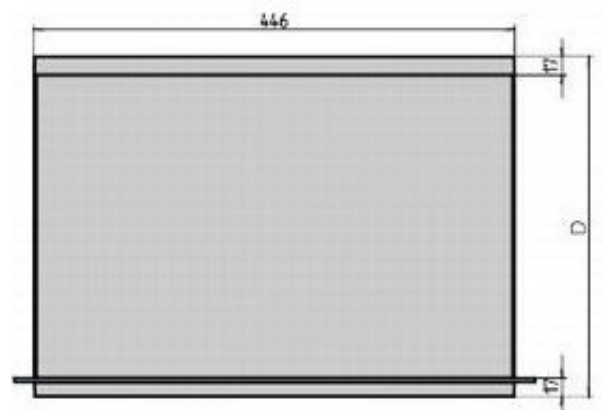
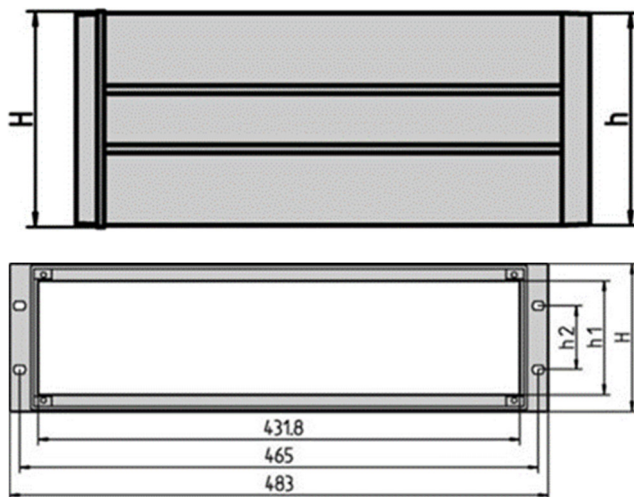

$H = 6HE, D = 434.5 \text{ mm}$

EAC-S 4000, EAC-S 5000, EAC-S 6000

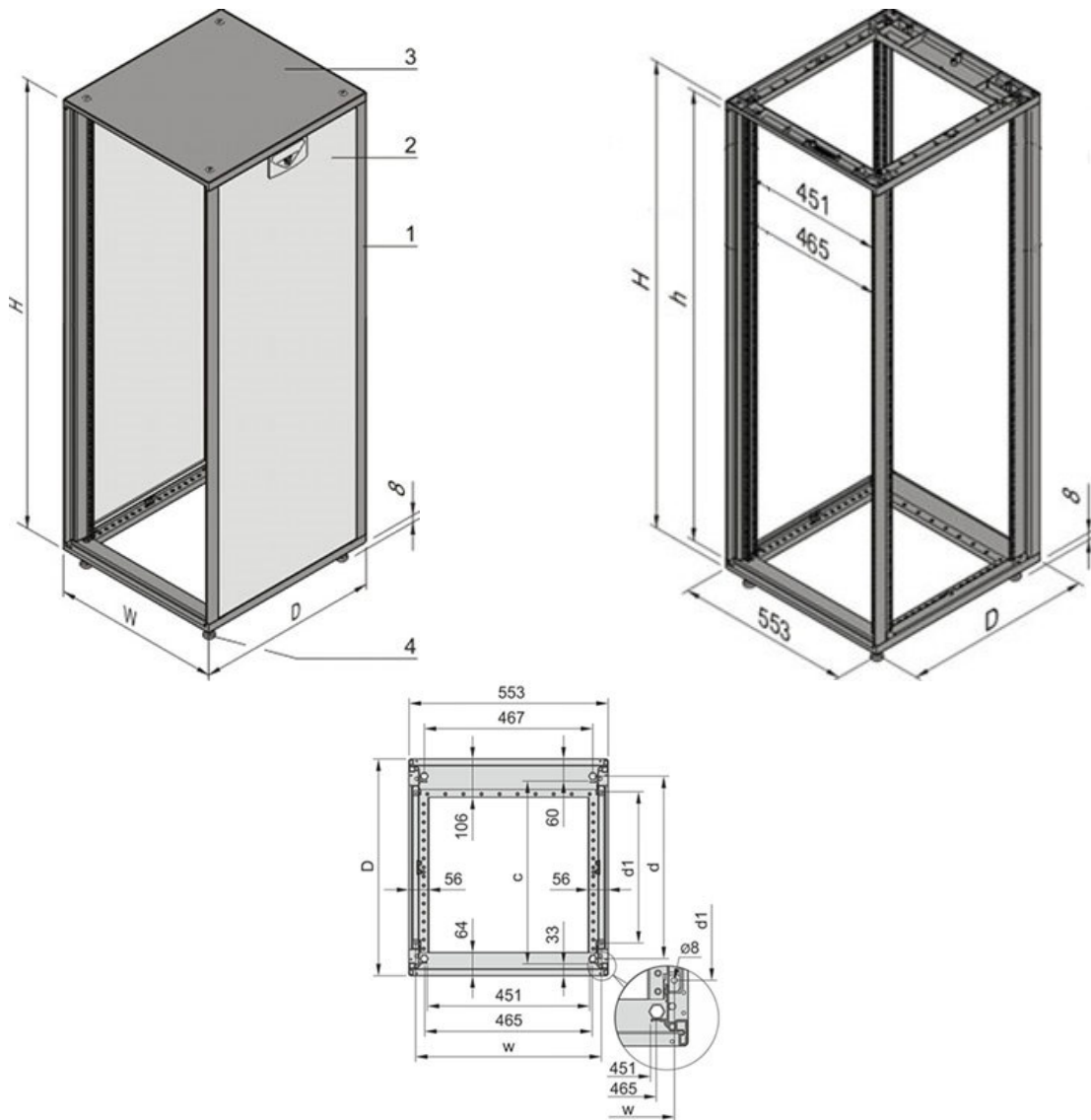

$H = 16HE, D = 600 \text{ mm}$

EAC-S 7000, EAC-S 8000

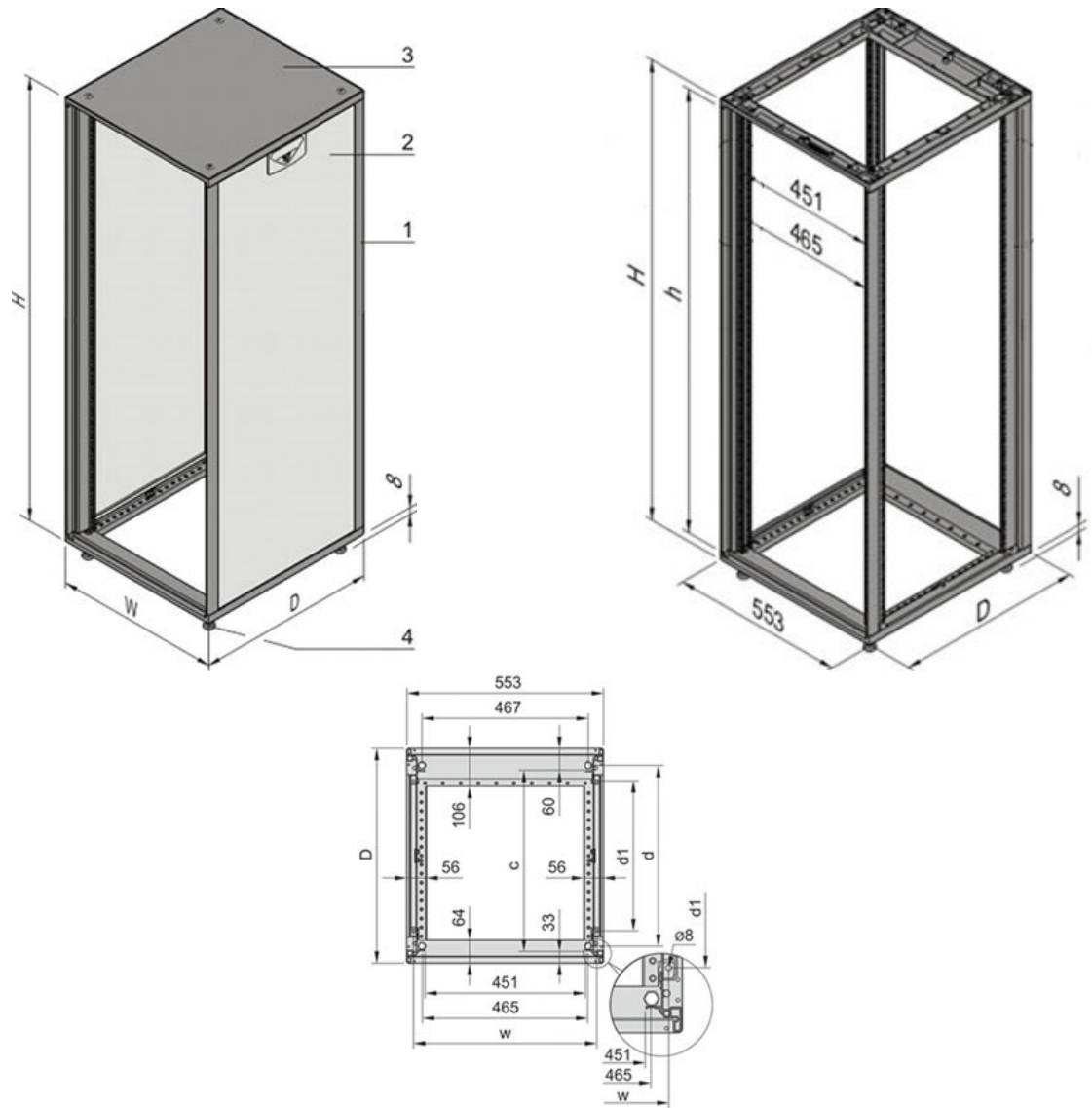

EAC-S 9000, EAC-S 10000

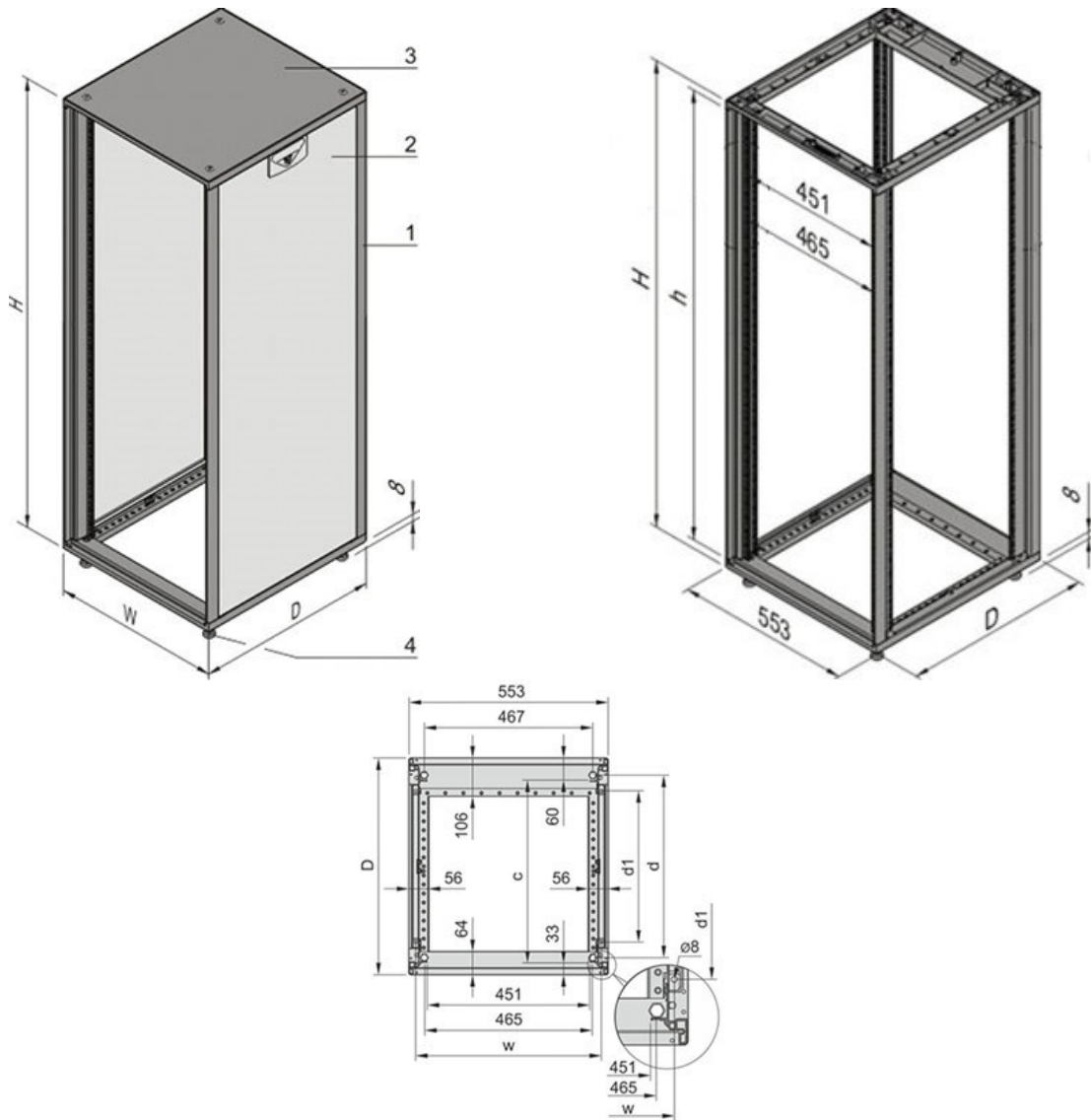

H = 25HE, D = 800 mm

4 IMPORTANT SAFETY INSTRUCTIONS



Please read this manual thoroughly before putting the device into operation. Pay regard to the following safety instructions and keep this manual nearby for future purpose.

This operating manual is based on the state of technology at the time of printing. However, it is possible that despite regular control and correction, the present document contains printing errors or deficiencies. ET System electronic GmbH assumes no liability for any technical, printing or translational errors within this manual.

4.1 INITIAL OPERATION

4.2 UNPACKING

Please make sure that the shipping carton and the packaging is free of damage. If external damage is found, it is important to record the type of damage. Please keep the original packaging to ensure the device is adequately protected in case it needs to be transported in the future or claims for compensation need to be asserted.

4.3 SETTING UP

To avoid electric shocks and product failure, the device should be installed in a temperature and humidity controlled indoor environment. The ambient temperature must not exceed 50 °C. The device must never be exposed to liquids or extreme humidity.

4.4 VISUAL INSPECTION

The unit must be examined immediately for defects or damages in transit. Damages caused during transport may be loose or broken control knobs and bent or broken connectors. Do not use the device if any physical damage is apparent. Please inform the carriers and a representative of ET System electronic immediately.

4.5 MAINS OPERATION

Make sure to verify the model number and voltage stated on the nameplate. Damages due to wrong power feed are not covered by guarantee conditions.



The unit must only be operated when connected directly to the mains. To avoid damage, do not connect the unit to isolating transformers, auto-transformers, magnetic current limiters or similar devices.

INTENDED USE

The device corresponds to protection class I and has a galvanic isolation between the input and the output circuit. The device must be grounded on the input side, since the grounding ensures protection against contact. In the case of locally variable devices, the earth is connected to the device by means of a cold-plug connector, and the ground is connected to the screw terminal provided for locally-variable devices (screw contacts at the grid input). In the case of devices with high leakage current (marking on the device), the existing grounding bolt must additionally be connected to the domestic installation earth. For compliance with the EMC and safety regulations (CE, approvals), the device may only be operated with PE connected. The device may only be operated by trained personnel and in accordance with the instructions for use. Typical fields of application are laboratories, industry and service engineering. Applications which can lead to injuries or death in the event of a fault in the device are not permitted.

5 FUNCTIONAL DESCRIPTION

The following block diagram gives information about the various adjustment options.

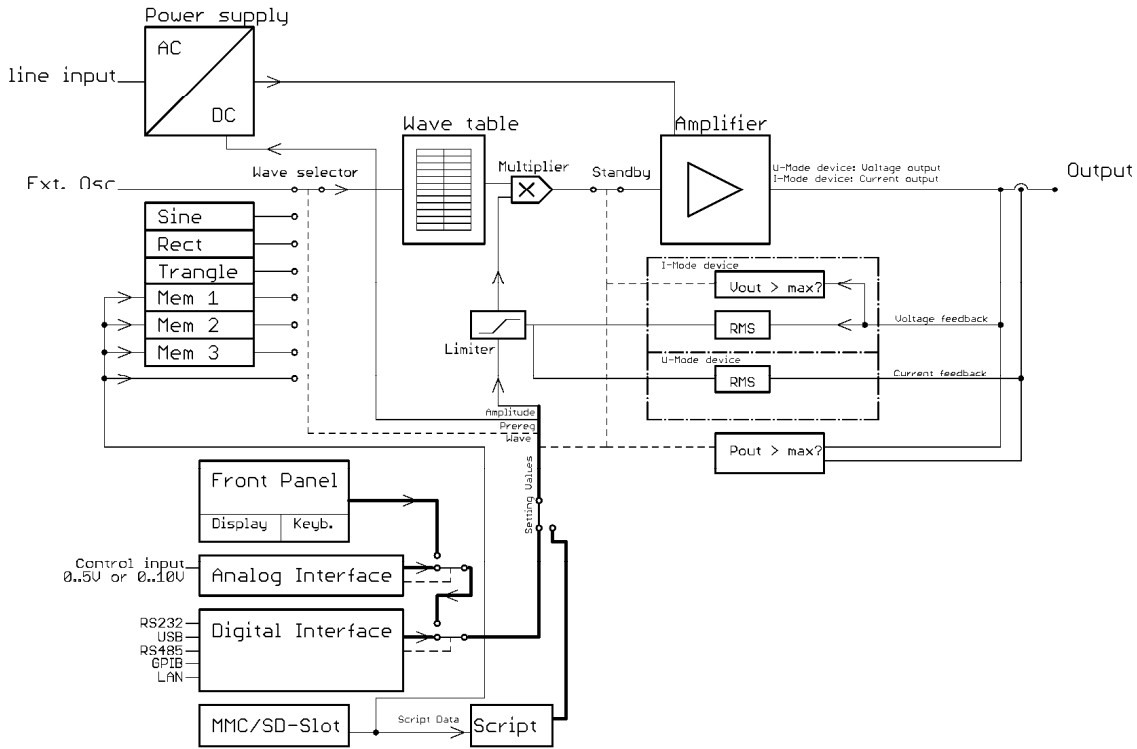

The supply voltage is rectified after the galvanic isolation and supplies an analog power amplifier. The input signal of the power amplifier is read from a table, which is loaded by control with one of the fixed curve shapes or a user defined curve shape. The table contains a period (20ms at 50Hz). The output voltage (I-Mode-Devices: output current) follows the table and the adjusted amplitude (if applicable with DC-Offset).

U-Mode Device	If the maximum adjustable output current (effective value) is exceeded, the amplitude will be reduced.
I-Mode Device	If the maximum adjustable output voltage (effective value) is exceeded, the amplitude will be reduced. Additionally, a monitoring is installed, which controls whether the output is open. If this is the case, an overload error is triggered and thus it avoids that the power amplify hits the stop with full DC voltage. The set points can be adjusted from different sources, depending on the device's equipment e. g. front panel, analog interface, digital interface or direct command from the memory card.

5.1.1 ATE-Version (Option ATE)

Devices with /ATE option have no operating elements available on the front side. The power output is lead through the back side of the device. All described functions may be accessed by an alternative interface then (e. g. computer).

5.1.2 External Release (Option Interlock)

The power transformer is primarily shut off by a contactor. A voltage of 230 V_{ac} must be applied to the input "Ext. Ein" to supply the power transformer with voltage and to apply a voltage to the output. The control of the device is supplied permanently to maintain the settings. This shutdown is no output isolation according to VDE. It is recommended to switch the control to standby mode before applying any voltage to the external release, because the adjusted voltage will be applied to the output immediately.

5.1.3 Output

On the front panel, the device is equipped with a grounding receptible for output power (0 - 250V 16A), as well as safety connectors for output power of 0 - U_{max} 23 A.

5.1.4 Input

Supply for the IEC connector or the supply clamps as well as the mains fuse are located on the back of the device. Before connecting the device to power supply please make sure that the mains socket matches the input voltage range of the device.

6 GENERAL SETTINGS

6.1 INITIAL STATE

The device is activated by pushing the button **Power** on the rear side. Afterwards the device is automatically in standby mode. There is no voltage applied to the output. After activation the device loads the settings from memory number 0. The following settings are available at delivery status: standby active, frequency 50 Hz, sine, adjusted voltage 0 V and adjusted current 0 A.

U-Mode	After pushing the button Standby Local the output voltage is adjusted with the angulum momentum sensor AC Voltage from 0 - U_{max} V _{ac} . The output current is adjusted with the angulum momentum sensor Current from 0 - I_{max} .
I-Mode	After pushing the button Standby Local the output current is adjusted with the angulum momentum sensor AC Current from 0 - I_{max} A _{ac} . The output voltage is adjusted with the angulum momentum sensor Voltage from 0 - U_{max} .

Optional, the following voltage ranges are available:

Option	Voltage range
Standard	0-300 V AC
/V500	0-500 V AC
/V700	0-700 V AC

The set points may be adjusted by console (→ chap. *Front panel operation*), interface (→ chap. *External control via computer*) or Analog/Digital-IO (→ chap. *External analog control*). In order of priority, commands which have been sent by interface come first, by analog/digital-IO come second and by console come third. For example, if the interface specifies the set point, the corresponding values will be sent - irrespective of other settings - to the output.

6.2 CONFIGURATION

Pushing the button **Save/Recal** opens the configuration menu. In this menu the general device adjustments can be changed. The LED of the corresponding button is active. Pushing the button **Display** toggles between save mode and load mode. The memory location is adjusted with the rotary pulse encoder **Frequency/Select**. Ten memory locations are available. When activating the device, the settings from memory location 0 are loaded. Irrespectively from the device settings, the device toggles to standby mode after loading a setting.

6.3 CONTRAST

After the device has been switched on, the display shows the ET System graphic. The contrast of the display can be adjusted by using the rotary pulse encoder **Frequency/Select**. Afterwards, the contrast will be saved.

7 FRONT PANEL OPERATION

7.1 CONSOLE AND ROTARY PULSE ENCODER

The console consists of five rotary pulse encoders and 16 buttons. The set points can be changed with the rotary pulse encoder. Pushing the rotary pulse encoder selects the desired value. Assigned to the first four rotary pulse encoders are three LEDs. The LEDs indicate the corresponding output channel for each rotary pulse encoder. The output channel can be adjusted by pushing the corresponding rotary pulse encoder. If all LEDs are active, the adjustments made before have an effect on all phases. The output channel is not adjustable on single-phased devices and LED **L1** is always active.

The following graphic shows an overview of the controls:

U-Mode device

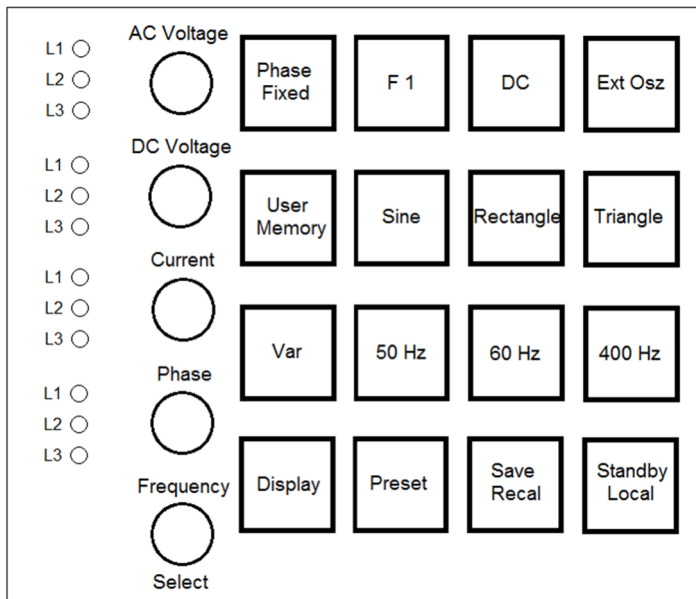

I-Mode device

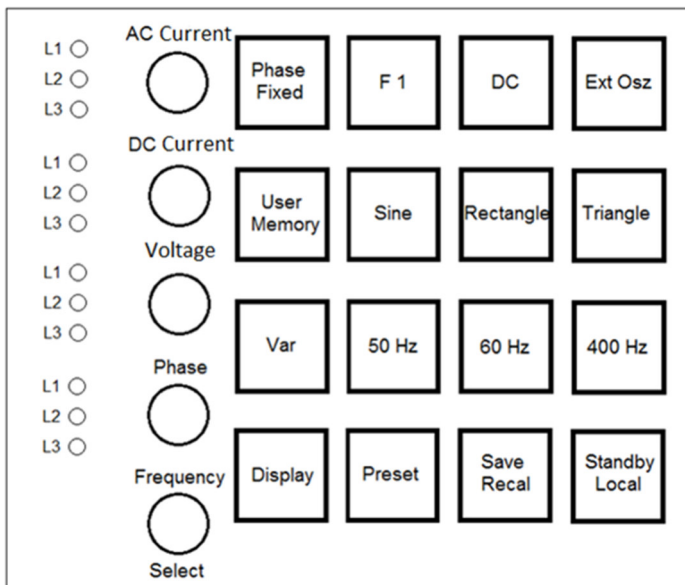

7.2 DISPLAYS AND SETTINGS

7.2.1 Actual measurements (display)

Pushing the button **Display** in normal mode switches between different displays. Some displays show *crest* factor ($CF = \text{maximum value} \div \text{effective value}$) or power factor ($PF = \text{active power} \div \text{apparent power}$).

These factors can only be calculated if the measure values are high enough. In case that measure values are too low and calculation might become imprecise, the display will show dashes instead of the calculated value (z. B. „CF -,----“).

7.2.2 Displaying the preset data

Pushing the button **Preset** Displays the adjusted set points. The corresponding LED on the button **Preset** indicates this mode. Pushing the button **Display** displays the set points for front panel operation, interface and analog/digital IO. The set point for output voltage is displayed in %. The effective value depends on the selected wave form. If the signal form is „sine“, „square“ or „triangle“, this value is displayed behind in brackets. In *Ext. Osz* mode, displaying the phase shifting is not suggestive; therefore the signal delay is displayed instead.

7.2.3 Selecting the wave form

Standard signals are selectable with the buttons **Sine**, **Rectangle** and **Triangle**. The external signal is selectable with the button **Ext Osz**. Therefore a signal is transmitted via the BNC connector on the rear side of the unit. The intensity of the signal must be adjusted with the rotary pulse encoder **AC Voltage** or **AC Current** (at I-mode devices). The signal will be used for 50 % if set to 50 %. The signal will be used for 100 % if set to 100 %. It is necessary to consider the maximum frequency of 500 Hz (optional 2000 Hz)! A user-defined or specialized wave form, which has been deposited in the memory can be selected with the button **User**.

7.2.4 Setting the frequency

Standard frequencies are selectable with the buttons **50 Hz**, **60 Hz** and **400 Hz**. In *Variable Frequency* mode (button **VAR.**) the frequency can be adjusted with the rotary pulse encoder **Frequency/Select** at a range from 0.1-fmax Hz. The increment is 0.1 Hz. The selected setting is indicated by the LEDs of the corresponding buttons.

7.2.5 Adjusting the phase

The phase shifting is adjusted with rotary pulse encoder number four. Phase adjustment on single- and three-phased devices is different.

Single-phased device	Output signal starts and stops at the adjusted phase angle.
Three-phased device	Phase shifting refers to an internal reference sine wave. The device is always activated or deactivated at the positive zero point of the reference sine wave.

Example: Phasing adjustment of a three-phased device

Phasing is adjusted from L1 to +90°. This means phase shifting for L1 is +90°. This means phase shifting for L1 is +90° compared to the internal reference sine wave. The device starts with a zero point of the internal reference sine wave when the output signal is active. L1 starts at -90°.

The following graphic shows adjustments of this example:

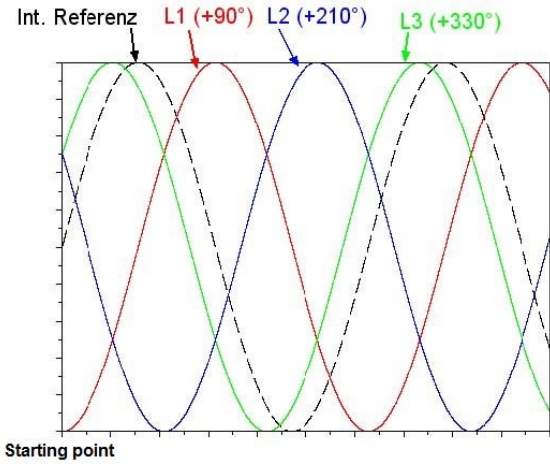

Example: Phase shifting

Adjustments: L1 = 90°, L2 = 210°, L3 = 330°

Phase shifting always refer to the reference sine wave, so the initial values are -90°, 150° und 30°. The button **Phase Fixed** selects a preset 3-phase-system with a phasing of 0°, 120° and 240°. This mode is signalized by the LED at the button **Phase Fixed**.

7.3 AMPLITUDE CONTROL

7.3.1 AC voltage

U-mode	The amplitude can be adjusted from 0 - U_{max} with the rotary pulse encoder AC Voltage .
I-mode	The amplitude can be adjusted from 0 - I_{max} with the rotary pulse encoder AC Current . Constant voltage mode is indicated by the word „U-Limit“ in the lower right corner of the display.

Option	Voltage range
Standard	0 - 300 V AC
/V500	0 - 500 V AC
/V700	0 - 700 V AC



To ensure that only one ac voltage is available the function DC must be inactive! The LED on the button DC must also be inactive!

7.3.2 DC voltage

U-mode	The dc voltage value can be adjusted from 0 - U_{max} with the rotary pulse encoder DC Voltage .
I-mode	The dc current value can be adjusted from 0 - I_{max} with the rotary pulse encoder DC Current . Constant voltage mode is indicated by the word „U-Limit“ in the lower right corner of the display.

The dc function must be activated by pushing the button **DC**. The corresponding LED is active, if the function is active. The polarity of the voltage is selected by turning the rotary pulse encoder: clockwise for positive values, counterclockwise for negative values. The dc voltage or dc current (I-mode devices) is added to ac voltage or ac current (I-mode devices). If a mixed voltage is not wanted, the ac voltage must be adjusted to 0 V. If only an ac voltage is desired, the dc function must be deactivated.

7.4 LIMITATION

U-mode	Current is adjusted with the rotary pulse encoder Current from 0 - I_{max} . On activation of the device, the value for current is 0 A. Constant current mode is indicated by the word „I-Limit“ in the lower right corner of the display. See the following table for an overview of the adjustment range for different types.
I-mode	Voltage is adjusted with the rotary pulse encoder Voltage from 0 - U_{max} . When switching on, the voltage value is set to 0 V. Constant voltage mode is indicated by the word „U-Limit“ in the lower right corner of the display.

Table: Adjustment range U-mode device types

Type	Adjustment range
EAC-S 250	0 - 3 A
EAC-S 500	0 - 6 A
EAC-S 1000	0 - 10 A
EAC-S 2000	0 - 15 A
EAC-S 3000	0 - 20 A
EAC-S 4000	0 - 30 A
EAC-S 5000	0 - 35 A
EAC-S 6000	0 - 40 A
EAC-S 7000	0 - 50 A
EAC-S 8000	0 - 60 A
EAC-S 9000	0 - 70 A
EAC-S 10000	0 - 80 A

7.5 SYNC OUTPUT (OPTION)

Located on the back of the device is a BNC connector which constantly outputs the sync signal. There is no need to activate a button. The signal is 3.3 V and has a rising edge with a rising sine.

7.6 SYNC INPUT (OPTION)

If the sync input is activated, the actual output curve will be synchronized with the sync inputs signal. Synchronization is carried out at the rising edge of the sync signal. The output signal can be shifted towards the sync signal by adjusting the phase.

Synchronization, Phase shifting 0°

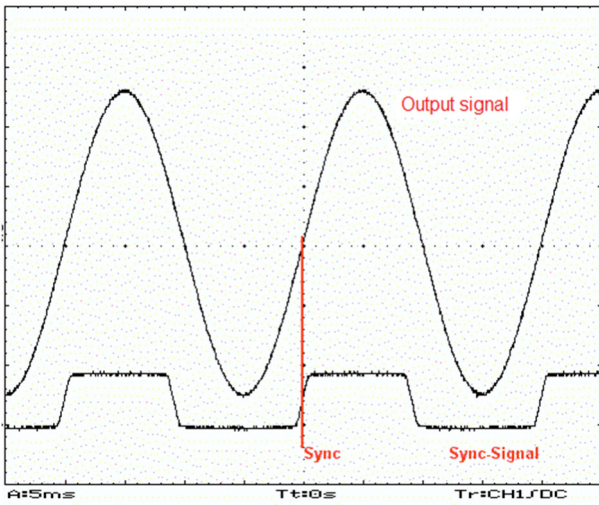

Synchronization, Phase shifting +90°

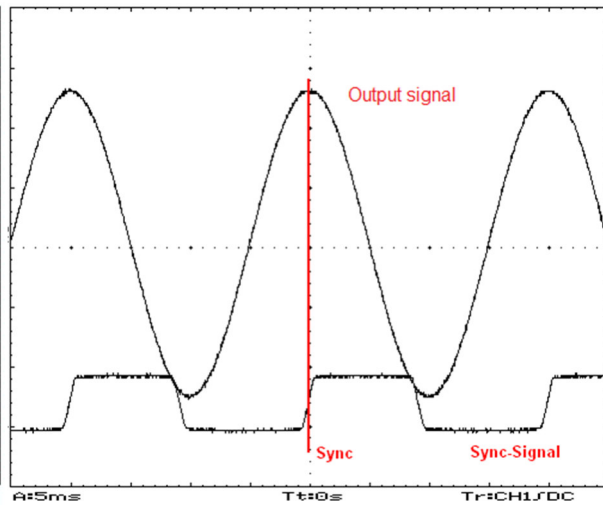

Synchronization, Phase shifting -90°

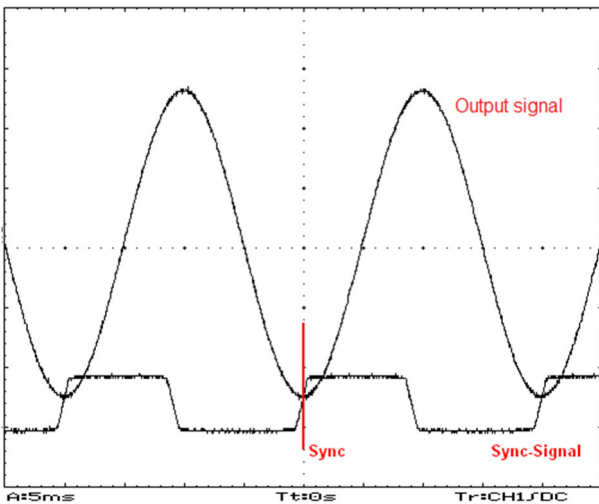

f(sync): 50 Hz f(output):48 Hz

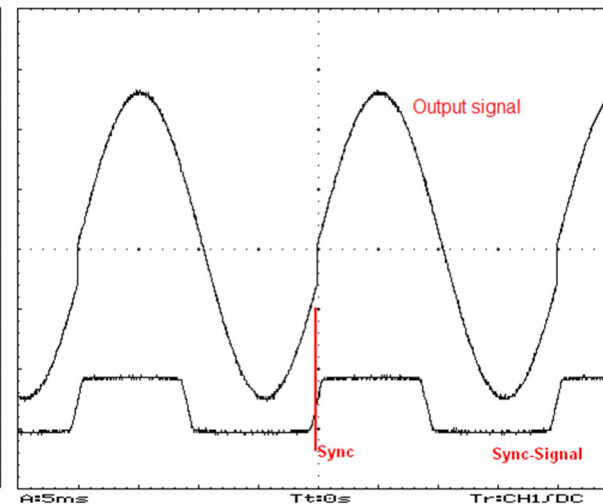

If the period duration of the output signal does not fit the sync signal, the output curve may be cutt off.



By cutting off the period an unwanted dc may occur on the output because the voltage time areas within the positive and negative half-cycle are unequal!

F(sync): 50 Hz f(output): 52 Hz

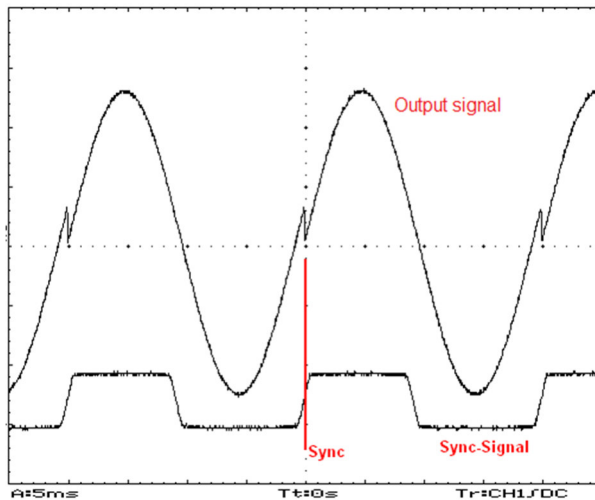

7.7 THREE-PHASE SYSTEM (OPTION /3S)

7.7.1 Control

On a three-phase system, the second and third phases are connected on the back of the device by a cable, with which the device can then be controlled. The connectors may not be interchanged. To run the system as a three-phase system, all three neutral conductors of the output must be connected among each other.

7.7.2 Activation/Deactivation

The order of the phases must be considered when activating or deactivating the device or all phases will be activated or deactivated at the same time.

Activation: L1, L2, L3

Deactivation: L3, L2, L1

7.8 PROGRAMMING OF THE WAVE FORM INTO THE INTERNAL MEMORY

Wave forms can be designed on a PC as 16 bit-wave files. These files consist out of 3600 samples which can be saved to an SD card or read in with a digital interface.

Pushing the button **User Memory** twice opens a menu (available are memory 1-3 and MMC direct). The cursor can be adjusted to the desired user memory number using the rotary pulse encoder **Frequency/Select**. Pushing the button **Save Recal** displays a checkbox dialog for the files previously saved on the SD card. The desired file can be selected with the rotary pulse encoder **Frequency/Select** and transferred to the internal memory of the device by pushing the rotary pulse encoder. Pushing the button **Save Recal** opens the internal memory of the device. The internal memory is selected with the rotary pulse encoder **Frequency/Select** and activated with the button **User Memory**. The wave is now available on the output of the device.

7.9 MMC DIRECT

The menu item „**MMC-Direct**“ can be used to directly upload wave forms directly from the memory card into the device. Pushing the rotary pulse encoder **Frequency/Select** selects a file and copies it directly to the output. Pushing the button **Display** will close the file menu. The wave form will not be saved, which means in case of a blackout or when switching to another wave form it will become lost.

7.10 ERROR MESSAGES

The device features an error display for overload which is indicated flashing in the lower right corner of the display.

A peak power can be driven for 10 seconds, which is higher than the nominal power. If this peak power is drawn for more than 10 seconds, the device is deactivated. On the display the word ‚Overload‘ is flashing. After 10 seconds the device is automatically reactivated and switches back to the previously adjusted voltage.

To draw a power higher than the peak power, results in an immediate deactivation of the device. On the display the word ‚Shutdown‘ is flashing. After 10 seconds the device is automatically reactivated and switches back to the previously adjusted voltage.

Type	Nominal power	Peak power
EAC-S 250	250 VA	350 VA
EAC-S 500	500 VA	750 VA
EAC-S 1000	1000 VA	1500 VA
EAC-S 2000	2000 VA	2500 VA
EAC-S 3000	3000 VA	3500 VA

Additional for I-mode devices: The output voltage runs high with open or high-impedance outputs. In this case, the device will be shutdown displaying the word ‚Overload‘.

7.11 STANDBY

The output voltage can be electronically activated or deactivated with the button *Standby Local*. The output is inactive and no voltage is applied, if the LED of the button *Standby Local* is active. The voltage adjusted by potentiometer *AC Current* or *Voltage* is applied to the output, if the corresponding LED is inactive.

8 3-PHASE-SYNC-FUNCTION (OPTION)

Use the sync-function to connect three single devices as a 3-phase-system, keep to the following steps: the zero conductors of the outputs of all three devices must be connected. One of the devices must be defined as master or phase L1. The sync-out connector of this device must be connected to the sync-in connectors of the other two devices L2/L3. The sync-out connector needs to be connected to the sync-in connectors using two BNC wires and a t-piece. Now all devices can be activated, taking care that all of them are adjusted to the same frequency. The sync button (**F1**) of device L2 and L3 must be pushed, activating the *Sync (F1)* LED. The phase shifting on the master device phase L1 must be adjusted to -120° and on the device phase L3 to $+120^\circ$ using the rotary pulse encoder *Phase*. The result is a 3-phase-voltage with clockwise-rotating field. Now the current and voltage can be adjusted using the rotary pulse encoders. The adjustment for each phase must be made separately for each phase on the corresponding device.

9 EXTERNAL OSCILLATOR: EXT OSZ (OPTION)

A control signal can be fed in via the BNC connector on the back of the device with the button *Ext Osz*. This signal is amplified on the power output. The amplitude of this signal can be adjusted with *AC-Voltage* (I-mode device: *AC-Current*). Voltage limitation (I-mode device: current limitation) is adjustable and the signal can be delayed using the rotary pulse encoder *Phase*.

10 EXTERNAL ANALOG CONTROL: /AI5, /AI10 (OPTION)

Operating modes can be activated and adjusted with the digital inputs of the AI interface. Output voltage, current and frequency can be adjusted via a dc voltage of 0-5 V DC (AI15) or 0-10 V DC (AI10) and can be read out at the monitor. These functions need to be ordered separately. The following overview shows the pin assignments of the three interface connectors. Interface 1 are digital outputs, interface 2 are digital inputs and interface 3 are analog inputs and outputs.

10.1 PIN ASSIGNMENT INTERFACE 1, DIGITAL OUTPUTS

1	open collector output IO	0 = analog interface active
2	open collector output DC L2	0 = output voltage L2 negative
3	open collector output I-limit	0 = current mode (I-mode: voltage mode)
4	open collector output overload	0 = overload
5	open collector output memory*	0 = output 6,18,19 display memory (see table 1)
6	open collector output square	0 = wave form square
7	open collector output PHAfix	0 = fixed phases 120, 240, 360 degrees
8	open collector output DC L1	0 = output voltage L1 negative
9	GND	
10	GND	
11	GND	
12	GND	
13	GND	
14	open collector output IEEE	0 = IEEE active
15	open collector output STBY	0 = output inactive
16	open collector output Shutdown	0 = shutdown overload (15 sec)
17	open collector output DC L3	0 = output voltage L3 negative
18	open collector output sine	0 = wave form sine
19	open collector output triangle	0 = wave form triangle
20	Sync	0 = Sync active
21	open collector output extern	0 = wave form of external input
22	GND	
23	GND	
24	GND	
25	GND	

*) If output no. 5 is activated, the outputs no. 6, 18, 19 display the memory location (see table 1).

Table 1

Output 10	Output 11	Output 12	Function
R	R	R	Memory 1
S	R	R	Memory 2
R	S	R	Memory 3
S	S	R	reserved
R	R	S	reserved
S	R	S	reserved
R	S	S	reserved
S	S	S	reserved

R = log 0

S = log 1

All digital outputs have an open-collector-output that can be loaded with 50 mA.

10.2 PIN ASSIGNMENT INTERFACE 2, DIGITAL INPUTS

1	input Select	0 = AI interface, open = front panel or IEEE
---	--------------	--

2	input DC neg DC L3	0 = dc voltage (I-mode: dc current) phase 3 negative, open = positive
3	input Fvar	0 = frequency variable
4	input F60	0 = 60 Hz mode
5	input Memory*	0 = select memory locations
6	input Square*	0 = square
7	input PHAfix	0 = fixed three-phase with 120, 240, 360 degree
8	input DC neg L1	0 = dc voltage (I-mode: dc current) phase 1 negative, open = positive
9	GND	
10	GND	
11	GND	
12	GND	
13	GND	
14	input DC neg L2	0 = dc voltage (I-mode: dc current) phase 2 negative, open = positive
15	input STBY	0 = standby mode, open = device active
16	input F50	0 = 50 Hz mode
17	input F400	0 = 400 Hz mode
18	input Sine*	0 = sine
19	input Triangle	0 = triangle
20	input Sync	0 = Synchronization on
21	input EXT	0 = External input (external wave form)
22	GND	
23	GND	
24	GND	
25	GND	

)* If memory (input 5) is activated, inputs no. 6 and 18 select the memory location (see table 2)

Digital inputs are connected internally with a 10 k resistance to +5 V. To select this function (= 0) the selected input must be connected to GND (pin 9, 10, 11, 12, 13). A frequency and a wave form need to be active.

Table 2

Input 6	Input 18	Function
open	open	memory 1
open	closed	memory 2
closed	open	memory 3
closed	closed	reserved

10.3 PIN ASSIGNMENT INTERFACE 3, ANALOG IN- AND OUTPUTS

Single-phased and three-phased devices have different analog inputs and outputs:

	Single-phased devices	Three-phased devices
1	input $U_{AC} (I_{AC})$ set	input $U_{AC} (I_{AC})$ set phase 1
2	input I (U) set	input I (U) set phase 1
3		input $U_{AC} (I_{AC})$ set phase 2
4		input I (U) set phase 2
5		input $U_{AC} (I_{AC})$ set phase 3
6		input I (U) set phase 3
7	input set frequency	input set frequency
8	output monitor U_{dc}	output monitor Leistung phase 1
9	output monitor power	output monitor U_{eff} phase 2
10	output monitor peak current	output monitor I_{eff} phase 2
11		output monitor power phase 3
12	output monitor frequency	output monitor frequency
13	GND (on SP devices: Ref_{out})	GND (on SP devices: Ref_{out})
14	input $U_{dc} (I_{dc})$ set	input $U_{dc} (I_{dc})$ set phase 1
15	input set phase	input set phase 1
16		input $U_{dc} (I_{dc})$ set phase 2
17		input set phase 2
18		input $U_{dc} (I_{dc})$ set phase 3
19		input set phase 3
20	output monitor U_{eff}	output monitor U_{eff} phase 1
21	output monitor I_{eff}	output monitor I_{eff} phase 1
22	output monitor peak voltage	output monitor power phase 2
23		output monitor U_{eff} phase 3
24		output monitor I_{eff} phase 3
25	GND	GND

10.4 CONNECTION EXAMPLES

10.4.1 Single-phase device control

Analog

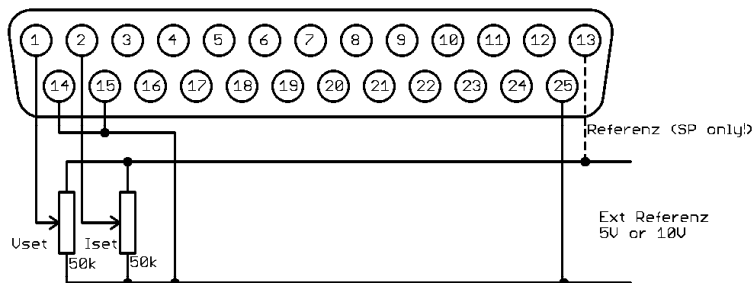

Digital In

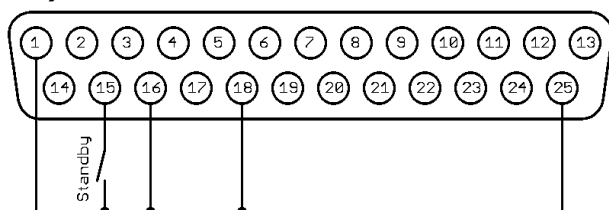

10.4.2 Three-phase device control

Analog

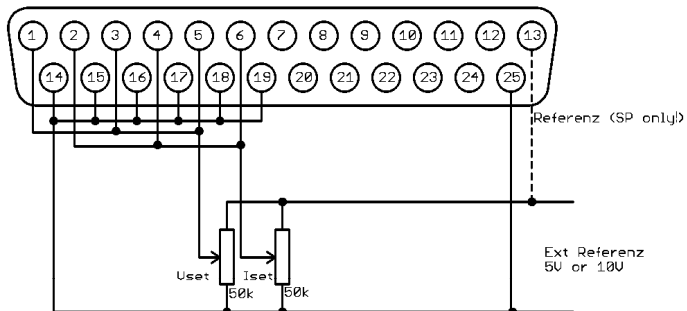

Digital In

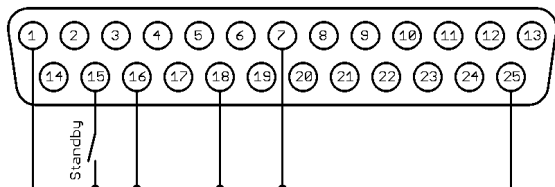

11 EXTERNAL CONTROL: COMPUTER (OPTION)

11.1 UNIVERSAL INTERFACE (OPTION /RS232; RS485; USB; LAN; IEEE)

All interfaces of the digital interface are equal. There is no shift between the interfaces. For example, the first command can be issued via the IEEE interface while the second command can be issued via the RS232 interface. The return values will be sent from the interface of which the command was issued.

11.2 ADJUSTING THE 6WAY DIP SWITCH

Changes on the DIP switch will only be assumed when the unit is activated. To change the DIP switch positions, it is necessary that the unit is switched off and on. Switch 6 is used for programming the firmware mode. This switch must be in **OFF** position.

11.3 COMMANDS

Communication is based on an ASCII protocol. Below is a description of the format and an overview of the different commands.

11.3.1 Format

A command consists of a commando, a parameter (if necessary) and a terminator. The character for a terminator is Carriage Return <CR> or Line Feed <LF>.

Character	ASCII	Value in dez	Value in hex
Carriage Return	<CR>	13	0d
Line Feed	<LF>	10	0a

If the command contains a or <ESC> character, the command will not be proceeded. Therefore, the command can be aborted during input. Thus, a terminator (<CR> or <LF>) is necessary.

Character	ASCII	Value in dez	Value in hex
Escape	<ESC>	27	1b
Delete		127	7f

Commands are not case sensitive and may be mixed up. Therefore, the effect of the following commands is the same: GTL, gtl and gTL. Decimal places are optional and separated by a full stop '.'. The number of decimal places is not limited. Therefore, the effect of the following commands is the same: UA,10, UA,10.0, UA,10.00000000, UA,0010, UA,010.0000. The number of decimal places to be analyzed depends on parameter and unit type. It corresponds to the number of decimal places, a command without a parameter would return. As a rule, decimal places are analyzed until a resolution of 0.1 % is reached.

Example: Evaluation of the decimal places

EAC-S with 300 V, 5 A
 $300 \text{ V} \cdot 0.1 \% = 0,3 \text{ V} \rightarrow$ one decimal place
 $5 \text{ A} \cdot 0.1 \% = 0,05 \text{ A} \rightarrow$ two decimal places

Optional, after a numerical value, a letter may be added to indicate the unit. However, this letter will not be analyzed.

Example: Attached letter as unit

UA,10.0 V \rightarrow sets the output voltage to 10 V
 UA,10.0 m \rightarrow Attention! The letter ,m' will not be analyzed, output voltage is also 10 V.

Example: Valid command with corresponding hex values

U	A	,	1	0	.	2	<CR>
55 h	41 h	2 ch	31 h	30 h	2 eh	32 h	0 dh

Example: Setting up an output voltage of 10 V/2 A (complete command sequence)

U-mode:
 UAC,10 → set output voltage to 10 V_{eff}
 IA,2 → current limiting 2 A
 SB,R → enable output

I-mode:
 IAC,4 → set output current to 4 A_{eff}
 UA,5 → voltage limiting 5 V
 SB,R → enable output

11.3.2 Reponse string

The response string consists of:

Command Comma Value Unit <CR> <LF>

The value is displayed as floating point number with a full stop ‘.’ as separator.

Command	Response string
IA	IA,12.34A
LIMUAC	LIMUAC,500.0V
LIMIA	LIMIA,30.00A

Example: Command as ASCII- and HEX-protocol:

L I M U A C , 5 0 0 . 0 V 0D 0A
 4C 49 4D 55 41 43 2C 35 30 30 2E 30 56 0D 0A

The decimal places correspond the resolution of the device.

Examples:

IA with a 20A device IAC,12.34A
 IA with a 5A device IA,0.005V

The pre-decimal places vary according to the measurement value.

Examples: 600 V device

UAC,10.4V
 UAC,220.3V
 UAC,1.1V

11.3.3 Instruction set

The IEEE-488.2 standard demands several basic commands. Some commands may occur twice for compatibility reasons (once in ET System version and once in the IEEE-488.2 version (e.g. ID and *IDN?).

The following syntax is used to describe the commands:

- [] Square brackets → optional parameter
- <> Pointed brackets → numerical value
- { } Curly brackets → selection list
- | Vertical stroke → separator in selection list

Example:

LLO[,{0|1}] means, the command LLO can be used with or without parameters. If a parameter is required, it needs to be 0 or 1. Therefore, valid commands are:

LLO
 LLO,0
 LLO,1

IA[,<imax>] means, the command IA can be used with or without parameters. If a parameter exists, it has to be a numerical value.

11.3.4 Overview of the commands

Command	Description	Result	U-mode	I-mode
CLS* or CLS	Clear Status	Deletes the status byte. No return value.	X	X
CYCLE[,{R S <Ton>,<Toff>}]	Cyclic Switching	Cyclic switching of the output.	X	X
DIP[,<time> S])	DIP	Short-term delay of the phase. Entering the command without parameters displays the adjusted time.	X	X
DCL	Device Clear	Resets the initialization data.	X	X
FA[,<frq>]	Frequency	Adjusts the frequency. Entering the command without parameters displays the actual set value.	X	X
FRQ[,<frq> DEFAULT]]	Frequency and default	Setting the frequency. If no parameter is entered, the current set point is displayed. The parameter DEFAULT causes the current set value to be stored as the default value. After switching on the source, the digital interface is initialized with this value.	X	X
GTL	Go To Local	Activates the front panel control. No return value.	X	X
GTR	Go To Remote	Activates the remote control. No return value.	X	X
GTR,0	Go To Remote	No automatic switch to remote control.	X	X
GTR,1	Go To Remote	Activates remote operation with first addressing.	X	X
GTR,2	Go To Remote	Activates remote operation immediately after the unit is activated. LOCAL blocked.	X	X
IA[,<Imax> DEFAULT]]	Output current and default	Setting the current limit. If no parameter is entered, the current set point is displayed. The parameter DEFAULT causes the current set value to be stored as the default value. After switching on the source, the digital interface is initialized with this value.	X	X
IA1[<Imax > DEFAULT]	Output current phase 1 and default	Adjusts current limiting of phase 1. If no parameter is entered, the current set point is displayed. The parameter DEFAULT causes the current set value to be stored as the default value. After switching on the source, the digital interface is initialized with this value	X	X
IA2[<Imax > DEFAULT]	Output current phase 2 and default	Adjusts current limiting of phase 2. If no parameter is entered, the current set point is displayed. The parameter DEFAULT causes the current set value to be stored as the default value. After switching on the source, the digital interface is initialized with this value	X	X
IA3[<Imax > DEFAULT]	Output current phase 3 and default	Adjusts current limiting of phase 3. If no parameter is entered, the current setpoint is displayed. The parameter DEFAULT causes the current set value to be stored as the default value. After switching on the source, the digital interface is initialized with this value	X	X
IAC[,<Imax>]	Output Current	Adjusts output current. Entering the command without parameters displays the actual set value.		X
IAC1[,<Imax>]	Output Current	Adjusts output current for phase 1.		X
IAC2[,<Imax>]	Output Current	Adjusts output current for phase 2.		X
IAC3[,<Imax>]	Output Current	Adjusts output current for phase 3.		X
ID or *IDN?	Identification	Displays the Identification String.	X	X
IDC[,<Imax>]	Output Current DC	Adjust output dc current.		X
IDC1[,<Imax>]	Output Current DC	Adjust output dc current for phase 1.		X
IDC2[,<Imax>]	Output Current DC	Adjust output dc current for phase 2.		X
IDC3[,<Imax>]	Output Current DC	Adjust output dc current for phase 3.		X
LIMFMAX	Maximum Frequency	Reads the maximum adjustment values.	X	X
LIMFMIN	Minimum Frequency	Reads the minimum adjustment values.	X	X
LIMIA	Maximum Output Current	Reads the maximum adjustment values.	X	X
LIMUAC	Maximum Output Voltage AC	Reads the maximum adjustment values. Adjustment range = LIMIdc.. + LIMIdc	X	X
LIMUDC	Maximum Output voltage DC	Reads the maximum adjustment values.	X	
LLO[,{1 0}]	Local Lockout	The parameter defines, whether the LLO status will be saved and whether the actual setting will be kept after a blackout. Entering the command without parameters deactivates the LOCAL button. No return value.	X	X
MCI	Crest Factor	Measures the Crest factor for current.	X	X
MCI1	Crest Factor	Measures the Crest factor for voltage of phase <MCI1>.	X	X
MCI2	Crest Factor	Measures the Crest factor for current of phase 1.	X	X
		Measures the Crest factor for current of phase 2.	X	X

Command	Description	Result	U-mode	I-mode
MCI3	Crest Factor	Measures the Crest factor for current of phase 3.	X	X
MCU	Crest Factor	Measures the Crest factor for voltage. Command is equivalent to command <MCU1>.	X	X
MCU1	Crest Factor	Measures the Crest factor for voltage of phase 1.	X	X
MCU2	Crest Factor	Measures the Crest factor for voltage of phase 2.	X	X
MCU3	Crest Factor	Measures the Crest factor for voltage of phase 3.	X	X
MFA	Measurement Frequency	Measures the output frequency.	X	X
MIA	Output Current	Measures the output current. Command is equivalent to command <MIA1>.	X	X
MIA1	Output Current	Measures the output current for phase 1.	X	X
MIA2	Output Current	Measures the output current for phase 2.	X	X
MIA3	Output Current	Measures the output current for phase 3.	X	X
MIDC	Output Current DC	Measures the dc current. Command is equivalent to command <MIDC1>.	X	X
MIDC1	Output Current DC	Measures the dc current for phase 1.	X	X
MIDC2	Output Current DC	Measures the dc current for phase 2.	X	X
MIDC3	Output Current DC	Measures the dc current for phase 3.	X	X
MIS	Output Current Peak Value	Measures the peak current. Command is equivalent to command <MIS1>.	X	X
MIS1	Output Current Peak Value	Measures the peak current for phase 1.	X	X
MIS2	Output Current Peak Value	Measures the peak current for phase 2.	X	X
MIS3	Output Current Peak Value	Measures the peak current for phase 3.	X	X
MPA	Power Measurement	Measures total power. Command is equivalent to command <MPA1>.	X	X
MPA1	Power Measurement	Measures total power of phase 1.	X	X
MPA2	Power Measurement	Measures total power of phase 2.	X	X
MPA3	Power Measurement	Measures total power of phase 3.	X	X
MPS	Power Measurement	Measures the apparent power. Command is equivalent to command <MPS1>.	X	X
MPS1	Power Measurement	Measures the apparent power of phase 1.	X	X
MPS2	Power Measurement	Measures the apparent power of phase 2.	X	X
MPS3	Power Measurement	Measures the apparent power of phase 3.	X	X
MPQ	Power Measurement	Measures the reactive power. Command is equivalent to command <MPQ1>.	X	X
MPQ1	Power Measurement	Measures the reactive power of phase 1.	X	X
MPQ2	Power Measurement	Measures the reactive power of phase 2.	X	X
MPQ3	Power Measurement	Measures the reactive power of phase 3.	X	X
MPF	Power Factor	Measures the Power factor. Command is equivalent to command <MPF1>.	X	X
MPF1	Power Factor	Measures the Power factor for phase 1.	X	X
MPF2	Power Factor	Measures the Power factor for phase 2.	X	X
MPF3	Power Factor	Measures the Power factor for phase 3.	X	X
MUA	Output Voltage	Measures the output voltage. Command is equivalent to command <MUA1>.	X	X
MUA1	Output Voltage	Measures output voltage for phase 1.	X	X
MUA2	Output Voltage	Measures output voltage for phase 2.	X	X
MUA3	Output Voltage	Measures output voltage for phase 3.	X	X
MUDC	Output Voltage	Measures dc voltage. Command is equivalent to command <MUDC1>.	X	X
MUDC1	Output Voltage DC	Measures dc voltage for phase 1.	X	X
MUDC2	Output Voltage DC	Measures dc voltage for phase 2.	X	X
MUDC3	Output Voltage DC	Measures dc voltage for phase 3.	X	X
MUS	Output Voltage Peak Value	Measures peak voltage. Command is equivalent to command <MUS1>.	X	X
MUS1	Output Voltage Peak Value	Measures peak voltage for phase 1.	X	X
MUS2	Output Voltage Peak Value	Measures peak voltage for phase 2.	X	X
MUS3	Output Voltage Peak Value	Measures peak voltage for phase 3.	X	X
MWAVE	Monitor Wave	Displays adjusted wave form.	X	X

Command	Description	Result	U-mode	I-mode
*OPT?	Optional Identification Query	Optional identification query.	X	X
PC[,<baud>,<parity>,<data bits>,<stop bits>,<handshake>,<echo>]	Program Communication	Adjusts the RS232 interface. Function is saved with the command <SS>. Entering the command without parameters displays the interface parameter.	X	X
PHA[<pha> DEFAULT]	Phase position and default value	Adjustment of the phase position. Corresponds to the command <PHA1>. If no parameter is entered, the current set point is output. The parameter DEFAULT causes the current set value to be stored as the default value. After switching on the source, the digital interface is initialized with this value	X	X
PHA1[<pha> DEFAULT]	Phase position for phase 1 and default value	Setting the phase position of phase 1: If no parameter is entered, the current setpoint is output. The parameter DEFAULT causes the current set value to be stored as the default value. After switching on the source, the digital interface is initialized with this value.	X	X
PHA2[<pha> DEFAULT]	Phase position for phase 2 and default value	Setting the phase position of phase 2: If no parameter is entered, the current set point is output. The parameter DEFAULT causes the current set value to be stored as the default value. After switching on the source, the digital interface is initialized with this value	X	X
PHA3[<pha> DEFAULT]	Phase position for phase 3 and default value	Setting the phase position of phase 3: If no parameter is entered, the current set point is output. The parameter DEFAULT causes the current set value to be stored as the default value. After switching on the source, the digital interface is initialized with this value	X	X
PL	Parameter LAN	Displays actual data (IP, Gateway, Mask, MAC) of the LAN interface. Reinitialization of the interface.	X	X
PR[,<baud>,<parity>,<data bits>,<stop bits>,<timeout>]	Program RS485	Adjusts the RS485 interface. Entering the command without parameters displays actual interface parameters. Function is saved with the command <SS>.	X	X
PU[,<baud>,<parity>,<data bits>,<stop bits>,<handshake>,<echo>]	Program USB	Adjusts the USB interface. Entering the command without parameters displays actual interface parameters. Function is saved with the command <SS>.	X	X
RI or *RST	Reset Instrument	Hardware reset. No return value.	X	X
*RST?	Reset Cause	Displays the cause for the last reset.	X	X
SB[,{S R <t>}]	Standby	Activates/deactivates the output.	X	X
SS or *PDU	Save Setup	Saves actual settings of ports and interface parameters in the EEPROM. No return value.	X	X
SS,UVORDELAY	Output voltage after pre-regulation	Activates the function. Output voltage is put out as soon as the thyristor controller is high enough. No return value	X	X
SS,UVORNODELAY	Output voltage after pre-regulation off	Deactivates the function. No return value.	X	X
STATUS	Status	Display status. Return value in binary format (see table).	X	X
SYNC[,{S R}]	Sync Input	Activation/deactivation of the sync input.	X	X
UA[,<spg>]	Output Voltage	Adjusts voltage. Entering the command without parameters displays the actual set value.		X
UA1[,<spg>]	Output Voltage	Adjusts the output voltage for phase 1.		X
UA2[,<spg>]	Output Voltage	Adjusts the output voltage for phase 2.		X
UA3[,<spg>]	Output Voltage	Adjusts the output voltage for phase 3.		X
UAC[<spg> DEFAULT]	Output voltage AC and default value	Setting the output voltage. If no parameter is entered, the current set point is output. The parameter DEFAULT causes the current set value to be stored as the default value. After switching on the source, the digital interface is initialized with this value	X	X
UAC1[<spg> DEFAULT]	Output voltage AC and default value for phase 1	Setting of the output voltage for phase 1. If no parameter is entered, the current setpoint is output. The parameter DEFAULT causes the current set value to be stored as the default value. After switching on the source, the digital interface is initialized with this value	X	X
UAC2[<spg> DEFAULT]	Output voltage AC and default value for phase 2	Setting of the output voltage for phase 2. If no parameter is entered, the current set point is output. The parameter DEFAULT causes the current set value to be stored as the default value. After switching on the source, the digital interface is initialized with this value	X	X

Command	Description	Result	U-mode	I-mode
UAC3[<spg> DEFAULT]	Output voltage AC and default value for phase 3	Setting of the output voltage for phase 3. If no parameter is entered, the current set point is output. The parameter DEFAULT causes the current set value to be stored as the default value. After switching on the source, the digital interface is initialized with this value	X	X
UDC[<spg> DEFAULT]	Output voltage DC and default value	Setting the DC offset. If no parameter is entered, the current set point is displayed. The parameter DEFAULT causes the current set value to be stored as the default value. After switching on the source, the digital interface is initialized with this value.	X	X
UDC1[<spg> DEFAULT]	Output voltage DC and default value for phase 1	Setting of the DC offset for phase 1. If no parameter is entered, the current set point is displayed. The parameter DEFAULT causes the current set value to be stored as the default value. After switching on the source, the digital interface is initialized with this value	X	X
UDC2[<spg> DEFAULT]	Output voltage DC and default value for phase 2	Setting of the DC offset for phase 2. If no parameter is entered, the current set point is displayed. The parameter DEFAULT causes the current set value to be stored as the default value. After switching on the source, the digital interface is initialized with this value	X	X
UDC3[<spg> DEFAULT]	Output voltage DC and default value for phase 2	Setting of the DC offset for phase 3. If no parameter is entered, the current set point is displayed. The parameter DEFAULT causes the current set value to be stored as the default value. After switching on the source, the digital interface is initialized with this value	X	X
WAV[,{MEM1 MEM2 MEM3 OUT}]	Output Signal	Loads a user-defined wave. The loading (MEM1 – MEM3) takes about 170ms time.	X	X
WAVE[,<Nr.>]	Output Signal	Adjusts the wave form.	X	X

11.3.5 Full description of commands

CLS* or CLS - Clear Status

Deletes the status byte from which the command was sent. No return value. See description of the corresponding interfaces for a detailed description of the status byte.

CYCLE[,{R|S}<Ton>,<Toff>}] - Cyclic switching

Cyclic switching of the output, that means the output is cyclic switched on and off for the times T_{on} and T_{off} . The time is adjustable within the range from 1 - 32767 s. The command **Cycle,S** activates the cycle mode. The command **Cycle,R** deactivates the cycle mode. Entering the command without parameters shows actual adjusted times, remaining times of the actual cycle and the status in the following format: CYCLE,<Ton>s,<Toff>s,<Tonrest>s,<Toffrest>s,{S|R}

The command **Standby,S** also deactivates the cycle mode.

Example:

```
GTR           Remote control
UAC,200       Output 200 V
IA,1          Current release 1 A
CYCLE,3,5    Cycle mode: 3 s on, 5 s off
CYCLE,S      Start cycle. Output voltage is active for 3 seconds and then inactive for 5 seconds.
CYCLE,R      End cycle
```

11.3.5.1 DCL - Device Clear

Resets the initialization data. Caution: Also resets the interface parameters! No return value!

DIP[,<t>|S] - DIP

Short-term delay of the phase for a selected period. <Time> adjusts the delay in ms (max. 30000 ms). <S> starts the delay. Entering the command without parameters displays the adjusted time. Delay starts at the zero point of the internal reference. The actual beginning of the delay may be influenced by the adjustment of the phasing (f = 50 Hz t_{dip} = 60 ms):

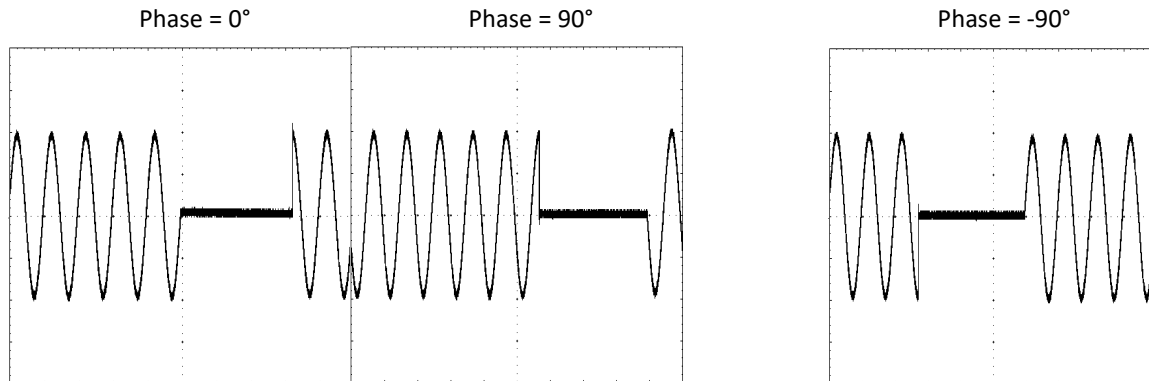
**Example: Curve shape phase = 90°**

GTR	Remote control
UAC,200	Output 200 V
IA,1	Current 1 A
PHA,90	Phasing 90°
SB,R	Output open
DIP,60	Adjust delay time to 60 ms
DIP	Read out adjusted delay time
DIP,60ms	Device answers 60 ms
DIP,S	Starts the delay. Output will be deactivated for 60 ms, starting at the next zero point of the internal reference sine.

Color marked lines represent the answer from the device.

FA[,<frq>] - Frequency

Adjusts the output frequency. Entering the command without parameters displays the actual set value.

Example:

GTR	Remote control
UAC,230	Output 230 V
IA,1	Current 1 A
FA,60	Output frequency 60 Hz
SB,R	Output open

FRQ[<frq>|DEFAULT] Output frequency and default value

Setting the output frequency. If no parameter is entered, the current setpoint is displayed. With DEFAULT the current value is permanently stored.

Example:

FRQ	-> (without parameter) returns the current set value
FRQ,60	-> The output frequency is set to 60 Hz
FRQ,DEFAULT	-> Current value is stored as default value

If the device is switched on in the future, the digital interface is initialized with (in this example) 60 Hz.

GTL - Go To Local

Activates front panel operation. If the adjustment 'Local Lockout' (LLO) was activated before, the adjustment will also be reset. No return value.

GTR - Go To Remote

Activates remote operation via digital interface. The optional parameter influences the behavior of the device after it has been activated. Adjustment will be saved permanently. No return value.

GTR[,{0}] - Go To Remote

Deactivates automatic remote operation. To start remote control the order **GTR** must be sent. This mode is useful, if the device shall be operated manually and measurement values shall be read out at the same time via digital interface. Adjustments will be saved though the unit is rebooted.

Example:

GTR	Remote control
UAC,230	Output 230 V
IA,1	Current 1 A
FA,60	Output frequency 60 Hz
SB,R	Output active
GTR,2	Remote control, adjustments will be saved permanently
RI	Reset, device automatically switches to remote control, because the command GTR,2 was sent before.
GTL	Device switches back to LOCAL mode

GTR[,{1}] - Go To Remote

Activates remote operation with first addressing. Remote mode will be activated, immediately after the device received a command from the digital interface. Exception: command **GTL**, switches the device to LOCAL mode. Adjustments will be saved though the unit is rebooted. Command is activated in delivery state.

GTR[,{2}] - Go To Remote

Activates remote operation immediately after the unit is activated. LOCAL blocked, operation via front panel is deactivated. Adjustments will be saved though the unit is rebooted.

IA[<Imax >|DEFAULT]- Output current and default value

Setting the current limit. In a three-phase device, IA sets the current limitation for all three phases simultaneously. If no parameter is entered, the current setpoint is displayed. If the setting value is greater than the maximum current of the device, the range error bit is set in the ESR register of the interface. In this case, the current set value remains unchanged. The setting value refers to the RMS value of the current. Alternatively, the parameter can be specified as a percentage.

Example: 30 A device

GTR	remote control mode
UAC,10	Output voltage 10 V
IA,10	Output current 10 A
SB,R	Output is enabled
IA.40	Output current 40 A. This command is ignored because the current is greater than the maximum current of the device. Rangeerror" is set in the status byte.
IA	Inquiry of the set current
IA,10.00A	Response from device: I _{max} = 10 A
IA.10%	Output current 3 A
IA	Inquiry of the set current
IA,3.00A	Response from device: I _{max} = 3 A

The **color-coded lines** represent the answer of the device.

This command saves the default value permanently.

Example:

IA -> (without parameter) returns the current set value
 IA,2 -> Output current is set to 2 A
 IA,DEFAULT -> Current value is stored as default value

If the device is switched on in the future, the digital interface is initialized with (in this example) 2A

IA1[<I_{max}>|DEFAULT] Output current and default value phase 1

Setting of current limitation and default value for phase 1.

IA2[<I_{max}>|DEFAULT] Output current and default value phase 2

Setting of current limitation and default value for phase 2.

IA3[<I_{max}>|DEFAULT] Output current and default value phase 3

Setting of current limitation and default value for phase 3.

IAC - Output current

Adjusts the output current. Entering the command without parameters displays the actual set value. On a three-phased device **<IAC>** sets the current limiting for all three phases at the same time. Entering the command without parameters displays the actual set value. If the set value is higher than the maximum current of the device, the range error bit within the ESR register is set. The actual set value stays the same. The set value refers to the effective value of the current. Alternatively, the parameter can be specified in percent.

Example: 30 A device

GTR	Remote control
UA,10	Output voltage 10 V
IAC,10	Output current 10 A
SB,R	Output active
IAC,40	Output current 40 A. This command will be ignored, since the current is higher than the maximum current of the device. „Rangeerror“ is set within the status bit.
IAC	Adjusted current query
IAC,10.00A	Answer from device: I _{max} = 10 A
IAC,10%	Output current 10 % of I _{max} = 3 A
IAC	Adjusted current query
IAC,3.00A	Answer from device: I _{max} = 3 A

Color marked lines represent the answer from the device.

IAC1[,<I_{max}>] - Output current

Adjusts output current of phase 1.

IAC2[,<I_{max}>] - Output current

Adjusts output current of phase 2. Command has no effect on single-phase devices.

IAC3[,<I_{max}>] - Output current

Adjusts output current of phase 3. Command has no effect on single-phase devices.

ID or IDN? - Identification

Displays the identification string (only available on single-phased devices).

IDC[,<I_{max}>] - Output DC current

Adjusts output DC current. Entering the command without parameters displays the actual set value. The adjustment of the output current for all three phases at the same time can be made with the command **<IDC>**. Entering the command without parameters displays the actual set value. If the set value is higher than the maximum current of the device, the range error bit within the ESR register is set. The actual set value stays the same. The set value refers to the effective value of the current. Alternatively, the parameter can be specified in percent.

Example: Generating a 2 A dc current with overlapped 1 A ac current

GTR	Remote control
UA,10	Output voltage 10 V
IAC,1	AC current 1 A
IDC,2	DC current 2 A
SB,R	Output active

IDC1[,<Imax>] - Output DC current

Adjusts the output DC current for phase 1.

IDC2[,<Imax>] - Output DC current

Adjusts the output DC current for phase 2.

IDC3[,<Imax>] - Output DC current

Adjusts the output DC current for phase 3.

LIMFMAX - Limit frequency max.

Readout of maximum set values.

Example:

LIMFMAX Maximum adjustable frequency query
LIMFMAX,500.0Hz Answer from device: 500 Hz

Color marked lines represent the answer from the device.

LIMFMIN - Limit frequency min.

Readout of minimum set values.

Example:

LIMFMIN Minimum adjustable frequency query
LIMFMIN,0.1Hz Answer from device: 0,1 Hz

Color marked lines represent the answer from the device.

11.3.5.2 LIMIA - Maximum output current

Readout of maximum set values.

Example:

LIMIA Maximum adjustable current query
LIMIA,6.00A Answer from device: 6 A

Color marked lines represent the answer from the device.

LIMUAC - Maximum output voltage AC

Readout of maximum set values.

Example:

LIMUAC Maximum adjustable voltage query
LIMUAC,500,0V Answer from device: 500 V

Color marked lines represent the answer from the device.

LIMUDC - Maximum output voltage DC

Readout of maximum set values. Adjustment range = LIMU_{dc} + LIMU_{dc}

Example:

LIMUDC Maximum adjustable voltage query
LIMUDC,425,0V Answer from device: 425 V_{dc}

Color marked lines represent the answer from the device.

LLO[,{1|0}] - Local Lockout

The parameter defines, whether the LLO status will be saved and whether the actual setting will be kept after a blackout. **LLO,0** deactivates the memory function. After a blackout, LLO will be initialized with 0 (= inactive). **LLO,1** activates the memory function. After a blackout LLO and "Local/Remote" will be initialized according to their last status. Entering the command without parameters deactivates LOCAL button; device cannot be switched to LOCAL mode. No return value.

Example:

GTR,2	Device switches to remote control immediately after start up
LLO,1	Settings from LLO will be saved
GTR	Remote control
LLO	Front panel control locked, Standby button will not switch to LOCAL mode
---	Blackout, device restarts and is now in remote operation mode. Front panel operation will not switch to manual control.

MCI - Crest factor

Measures Crest factor of actual current. $CF = I_{max} \div I_{eff}$. Command is equivalent to command **<MCI1>**.

MCI1 - Crest factor

Measures Crest factor for current of phase 1.

MCI2 - Crest factor

Measures Crest factor for current of phase 2. Command has no effect on single-phased devices.

MCI3 - Crest factor

Measures Crest factor for current of phase 3. Command has no effect on single-phased devices.

MCU - Crest factor

Measures Crest factor for actual voltage. $CF = U_{max} \div U_{eff}$. Command is equivalent to command **<MCU1>**.

MCU1 - Crest factor

Measures Crest factor for voltage of phase 1.

MCU2 - Crest factor

Measures Crest factor for voltage of phase 2. Command has no effect on single-phased devices.

MCU3 - Crest factor

Measures Crest factor for voltage of phase 3. Command has no effect on single-phased devices.

MFA[,<fra>] - Output frequency measurement

Measures the output frequency. The measuring of the output frequency and generating the signal form have equal time bases, therefore the measured value is consistent with the set value (command **<FA>**).

MIA - Output current

Measures the actual effective value of the output current. The measurement includes the real effective value considering the dc amount. Command is equivalent to command **<MIA1>**.

Example:

GTR	Remote control
UAC,10	Output voltage 10 V
IA,1	Output current 1 A
SB,R	Output active
MIA	Measures the actual output current
MIA,0.567A	Answer from device: 567 mA

Color marked lines represent the answer from the device.

MIA1 - Output current

Measures the output current of phase 1.

MIA2 - Output current

Measures the output current of phase 2. Command has no effect on single-phased devices.

MIA3 - Output current

Measures the output current of phase 3. Command has no effect on single-phased devices.

MIDC - Output current DC

Measures DC current. Command is equivalent to command **<MIDC1>**.

Example:

GTR	Remote control
UAC,10	Output voltage 10 V
IA,1	Output current 1 A
SB,R	Output active
MIDC	Measures actual output voltage
MIDC,0.01A	Answer from device: 10 mA

Color marked lines represent the answer from the device.

MIDC1 - Output DC current

Measures the DC current of phase 1.

MIDC2 - Output DC current

Measures the DC current of phase 2. Command has no effect on single-phased devices.

MIDC3 - Output DC current

Measures the DC current of phase 3. Command has no effect on single-phased devices.

MIS - Output current peak value

Measures the actual peak value of the output current. Command is equivalent to command **<MIS1>**.

MIS1 - Output current peak value

Measures the actual peak value of phase 1.

MIS2 - Output current peak value

Measures the actual peak value of phase 2. Command has no effect on single-phased devices.

MIS3 - Output current peak value

Measures the actual peak value of phase 3. Command has no effect on single-phased devices.

MPA - Total power

Measures total power. Command is equivalent to the command **<MPA1>**.

Example: single-phase device, inductive load

GTR	Remote control
UAC,10	Output voltage 10 V
IA,1	Output current 1 A
SB,R	Output active
MUA	Measures actual output voltage
MUA,10.0 V	Answer from device: 10 V
MIA	Measures actual output current
MIA,0.800A	Answer from device: 800 mA
MPA	Measures actual output power
MPA,6.400W	Answer from device: 6,4 W
MPF	Measures actual power factor
MPF,0.8000	Answer from device: cosphi = 0,8

Color marked lines represent the answer from the device.

MPA1 - Total power

Measures total power of phase 1.

MPA2 - Total power

Measures total power of phase 2. Command has no effect on single-phased devices.

MPA3 - Total power

Measures total power of phase 3. Command has no effect on single-phased devices.

MPS - Apparent power

Measures apparent power. Command is equivalent to the command **<MPA1>**.

MPS1 - Apparent power

Measures apparent power of phase 1.

MPS2 - Apparent power

Measures apparent power of phase 2. Command has no effect on single-phased devices.

MPS3 - Apparent power

Measures apparent power of phase 3. Command has no effect on single-phased devices.

MPQ - Idle power measurement

Measures actual idle power. Command is equivalent to the command **<MPQ1>**. $Q = \sqrt{(U * I)^2 - P^2}$

Example: single-phase device. inductive load

GTR	Remote control
UAC,200	Output voltage 200 V
IA,10	Output current 10 A
SB,R	Output active
MPS	Measures actual apparent power
MPS,1312VA	Answer from device: 1312 VA
MPA	Measures actual output power
MPA,1050W	Answer from device: 1050 W
MPQ	Measures actual idle power
MPQ,786.7var	Answer from device: 786,7 var

Color marked lines represent the answer from the device.

MPQ1 - Idle power measurement

Measures idle power of phase 1.

MPQ2 - Idle power measurement

Measures idle power of phase 2. Command has no effect on single-phased devices.

MPQ3 - Idle power measurement

Measures idle power of phase 3. Command has no effect on single-phased devices.

MPF - Power factor

Measures actual power factor. $PF = P \div (U_{\text{eff}} \times I_{\text{eff}})$. Command is equivalent to the command **<MPF1>**.

Example: single-phase device. inductive load

GTR	Remote control
UAC,10	Output voltage 10 V
IA,1	Output current 1 A
SB,R	Output active
MPF	Measures the actual power factor
MPF,0.8000	Answer from device: cosphi = 0,8

Color marked lines represent the answer from the device.

MPF1 - Power factor

Measures power factor of phase 1.

MPF2 - Power factor

Measures power factor of phase 2. Command has no effect on single-phased devices.

MPF3 - Power factor

Measures power factor of phase 3. Command has no effect on single-phased devices.

MUA - Output current

Measures actual effective value of the output voltage. The measurement includes the real effective value considering the dc amount. Command is equivalent to command **<MUA1>**.

Example: three-phase device

GTR	Remote control
UAC,10	Output voltage 10 V
IA,1	Output current 1 A
SB,R	Output active
MUA1	Measures actual output voltage
MUA1,10.0V	Answer from device: 10 V
MUA2	Measures actual output voltage
MUA2,10.0V	Answer from device: 10 V
MUA3	Measures actual output voltage
MUA3,4.0 V	Answer from device: 4 V → Phase 3 is in current limitation

Color marked lines represent the answer from the device.

MUA1 - Output voltage

Measures output voltage of phase 1.

MUA2 - Output voltage

Measures output voltage of phase 2. Command has no effect on single-phased devices.

MUA3 - Output voltage

Measures output voltage of phase 3. Command has no effect on single-phased devices.

MUDC - Output voltage DC

Measures the DC voltage. Command is equivalent to command **<MUDC1>**.

MUDC1 - Output voltage DC

Measures the dc voltage of phase 1.

MUDC2 - Output voltage DC

Measures the dc voltage of phase 2. Command has no effect on single-phased devices.

MUDC3 - Output voltage DC

Measures the dc voltage of phase 3. Command has no effect on single-phased devices.

MUS - Output voltage peak value

Measures the actual peak value of the output voltage. Command is equivalent to command **<MUS1>**.

Example:

GTR	Remote control
UAC,10	Output voltage 10 V
IA,1	Output current 1 A
SB,R	Output active
MUA	Measures actual output voltage
MUA,10.0V	Answer from device: 10 V (Effective value)
MUS	Measures actual peak voltage
MUS,14.4V	Answer from device: 14,4 V
MUDC	Measures actual DC voltage
MUDC,0.0V	Answer from device: 0 V

Color marked lines represent the answer from the device.

MUS1 - Output voltage peak value

Measures peak voltage of phase 1.

MUS2 - Output voltage peak value

Measures peak voltage of phase 2. Command has no effect on single-phased devices.

MUS3 - Output voltage peak value

Measures peak voltage of phase 3. Command has no effect on single-phased devices.

MWAVE - Monitor wave

Displays adjusted wave form. Command is equivalent to command **WAVE** without parameters.

***OPT? - Optional Identification Query**

Optional identification query. Displays the version of the hardware/MCU/DSP/interface.

Example:

*OPT?	Version number query
03/2013 V2.69.42.28.1	Answer from device: Version 2.69.42.28.1

Color marked lines represent the answer from the device.

PC[,<baud>,<parity>,<data bits>,<stop bits>,<handshake>,<echo>] - Program Communication

Adjusts the RS232 interface. Entering the command without parameters displays the interface parameter. Function is saved with the command **<SS>**. No return value.

Parameter	Effect
-----------	--------

<baud>	Adjusts the baud rate in bps. Valid parameters: 1200, 2400, 4800, 9600, 14400, 19200, 38400, 57600, 62500, 115200
<parity>	Adjusts the data parity: O = Odd = odd parity E = Even = even parity N = None = no parity bit
<data bits>	Number of data bits 7, 8
<stop bits>	Number of stop bits 1, 2
<handshake>	Handshake: H = Hardware (RTS/CTS) S = Software (XON/XOFF) N = None (no handshake)
<echo>	Echo adjustment: E = Echo = Echo on N = None = Echo off

Example:

```

PC          Parameter query of interface 1
PC,9600,N,8,2,N,E  Answer from device: 9600 baud, 8 data bits,2 stop bits, no handshake, no parity, echo on
PC,115200,N,8,2,N,E Adjusts the baud rate to 115200 baud. The new baud rate is active immediately after the command was send!
SS          Save settings
    
```

Color marked lines represent the answer from the device.

PHA[<pha>| |DEFAULT] Phase position and default value

Adjustment of the phase position. Corresponds to the command <PHA1>. The phase position refers to the internal reference phase. If no parameter is entered, the current setpoint is output. Value range: 0.0°-359.9°. With DEFAULT the current value is permanently stored.

Example:

```

PHA          -> (without parameter) returns the current set value
PHA,90       -> The phase position is set to 90°.
PHA,DEFAULT  -> Current phase position Value is stored as default value
    
```

If the device is switched on in the future, the digital interface is initialized with (in this example) 90° phase position.

PHA1[<pha>| |DEFAULT] Phase position and default value phase 1

Adjusts the phasing of phase 1 and default value.

PHA2[<pha>| |DEFAULT] Phase position and default value phase 1

Adjusts the phasing of phase 2 and default value. Command has no effect on single-phased devices.

PHA3[<pha>| |DEFAULT] Phase position and default value phase 1

Adjusts the phasing of phase 3 and default value. Command has no effect on single-phased devices.

PL - Parameter LAN

Displays actual data (IP, Gateway, Mask, MAC) of the LAN interface. The interface is reinitialized. If the interface automatically refers to its IP, the IP may be requested again. Existing connections may eventually become disturbed. The processing of this command may take up to 20 seconds!

PR[,<baud>,<parity>,<data bits>,<stop bits >,<timeout>] - Program RS485

Adjusts the RS485 interface. Entering the command without parameters displays the actual interface parameters. Function is saved with the command <SS>. No return value.

Valid parameters: <baud>,<parity>,<data bits>,<stop bits>,<timeout>

Parameter	Effect
<baud>	Adjusts the baud rate in bps. Valid parameters: 1200, 2400, 4800, 9600, 14400, 19200, 38400, 57600, 62500, 115200
<parity>	Adjusts the data parity:

	O = Odd = odd parity E = Even = even parity N = None = no parity bit
<data bits>	Number of data bits 7, 8
<stop bits>	Number of stop bits 1, 2
<timeout>	Timeout in ms from receiving a command to switching to transmission mode. 0...100

Example:

```

PR          Parameter query of interface 1
PR,9600,N,8,1,1  Answer from device: 9600 baud, 8 data bits, 1 stop bit, no parity, timeout 1 ms
PR,9600,N,8,1,50 Increase timeout to 50 ms
SS          Save settings

```

Colour marked lines represent the answer from the device.

PU[,<baud>,<parity>,<data bits>,<stop bits>,<handshake>,<echo>] - Program USB

Adjusts the USB interface. Entering the command without parameters displays the actual interface parameters. Function is saved with the command **<SS>**.

Configuration of the interface in delivery state: 9600 baud, 8 data bits, 1 stop bit, no handshake, echo on.

Valid parameters of the USB interface: <baud>,<parity>,<data bits>,<stop bits>,<timeout>,<echo>

Parameter	Effect
<baud>	Adjusts the baud rate in bps. Valid parameters: 1200, 2400, 4800, 9600, 14400, 19200, 38400, 57600, 62500, 115200
<parity>	Adjusts the data parity: O = Odd = odd parity E = Even = even parity N = None = no parity bit
<data bits>	Number of data bits 7, 8
<stop bits>	Number of stop bits 1, 2
<timeout>	Timeout in ms from receiving a command up to switching to transmission mode. 0...100
<echo>	Adjusts the echo: E = Echo = Echo on N = None = Echo off

Example:

```

PU          Parameter query of interface 1
PU,9600,N,8,1,N,E  Answer from device: 9600 baud, 8, data bits, 1 stop bit, no handshake, no parity, echo on
PU,115200,N,8,1,N,E Adjust baud rate to 115200. New baud rate is active immediately after the command was sent!
SS          Save settings

```

Color marked lines represent the answer from the device.

RI or *RST - Reset Instrument

Software reset. No return value.

***RST? - Reset Cause**

Displays the cause for the latest reset.

SB[,{S|R|x}] - Standby

Activates/Deactivates the output. **SB,S** deactivates the output. **SB,R** activates the output. **SB,x** activates the output for x milliseconds (x = value between 10-32000 \triangleq 10ms-320s). Entering the command without parameters displays the actual operation mode.

Example:

GTR Remote control
 SB Standby status query
 SB,S Answer from device: output locked.
 UAC,100 Output voltage 100 V
 IA,1 Output current 1 A
 SB,500 Output active for 500 ms

Color marked lines represent the answer from the device.

SS or *PDU - Save Setup

Saves actual settings of ports and interface parameters in the EEPROM. No return value.

SS,UVORDELAY - Output voltage after pre-regulation

Activates the function. Output voltage is put out as soon as the thyristor controller is high enough. No return value.

SS,UVORNODELAY - Output voltage after pre-regulation off

Deactivates the function. No return value.

STATUS - Status

Display status. Return value: STATUS, XXXXXXXXXXXXXXXX (X: 1 or 0, MSB on the left).

Function of the status bits:

Bit	Function	
0	remote	1 = remote control, 0 = front panel control
1	lock	1 = front panel operation locked
2	used internally	
3	standby	1 = output locked, 0 = output open
4	wave ok	1: wave ok (see command WAVE)
5	set value	1: set value was put out
6	not in use	
7	not in use	
8	signal form	
9	signal form	000 = External, 001 = Sine, 010 = Square, 011 = Triangle, 100 = Memory1, 101 = Memory2, 110 = Memory3, 111 = MMC-Direct
10	signal form	
11	not in use	
12	not in use	
13	current limiting	1 = current limiting (I-Limit)
14	overpower warning	1 = power drain bigger than nominal power (overload)
15	overpower lockdown	1 = power drain higher than peak output (shutdown)

Example:

STATUS Status byte query
 STATUS,0000001000001000 Answer from device: local mode, standby, sine

Color marked lines represent the answer from the device.

SYNC[,{S|R}] - Sync input

Activation/Deactivation of the sync input. The command for activation is **SYNC,S** or **SYNC,1**. The command for deactivation is **SYNC,R** or **SYNC,0**. Entering the command without parameters displays the actual operation mode.

UA[,<umax>] - Output voltage

Adjusts maximum output voltage. Entering the command without parameters displays the actual set value. To adjust the output voltage at three-phased devices for all phases, use the command **UA**. The commands **UA1**, **UA2** and **UA3** only effect the corresponding phase. The commands **UA** and **UA1** have the same effect.

If the set value is higher than the maximum voltage of the device, the range error bit within the ESR register is set. The actual set value stays the same. The parameter refers to the effective value of the sinusoidal ac voltage. Alternatively, the parameter can be specified in percent, which is useful with sinusoidal output voltages.

Example: 300 V device

GTR	Remote control
UA,230	Output voltage 230 V _{eff}
IAC,10	Output current 10 A
SB,R	Output active
UA,400	Output voltage 400 V. Command will be ignored because the actual voltage is higher than the maximum voltage of the device. „Rangeerror“ will be set in the status byte.
UA	Adjusted voltage query
UA,230.0V	Answer from device: 230 V
UA,10%	Output voltage 10 % of 300 V → 30 V _{eff}
UA	Adjusted voltage query
UA,30.0V	Answer from device: 30 V

Color marked lines represent the answer from the device.

UA1[,<umax>] - Output voltage

Adjusts the voltage of phase 1.

UA2[,<umax>] - Output voltage

Adjusts the voltage of phase 2. Command has no effect on single-phased devices.

UA3[,<umax>] - Output voltage

Adjusts the voltage of phase 3. Command has no effect on single-phased devices.

UAC[,<spg>] - Output voltage

Setting the AC output voltage. If no parameter is entered, the current setpoint is displayed. In three-phase devices, the voltage for all three phases is set simultaneously. The UAC command sets the AC output voltage for all three phases. The commands **UAC1**, **UAC2** and **UAC3** only affect the corresponding phases. For single-phase devices, the commands UAC and UAC1 have the same effect.

If the setting value is greater than the maximum voltage of the device, the range error bit is set in the ESR register of the interface. In this case, the current set value remains unchanged. The parameter refers to the rms value of the sinusoidal alternating voltage. Alternatively, the parameter can be specified as a percentage. This is particularly useful for non-sinusoidal output voltages.

Example: 300 V device

GTR	Remote control
UAC,230	Output voltage 230 V _{eff}
IA,10	Output current 10 A
SB,R	Output active
UAC,400	Output voltage 400 V. Command will be ignored because the actual voltage is higher than the maximum voltage of the device. „Rangeerror“ will be set in the status byte.
UAC	Adjusted voltage query
UAC,230.0V	Answer from device: 230 V
UAC,10%	Output voltage 10 % of 300 V → 30 V _{eff}
UAC	Adjusted voltage query
UAC,30.0V	Answer from device: 30 V

Color marked lines represent the answer from the device.

This command saves the default value permanently.

Example:

UAC	-> (without parameter) returns the current set value
UAC,115	-> The output voltage is set to 115VAC
UAC,DEFAULT	-> Current AC voltage value is stored as default value

If the device is switched on in the future, the digital interface is initialized with (in this example) 115VAC output voltage.

UAC1[<umax>|DEFAULT] - Output voltage and default value phase 1

Adjusts output voltage of phase 1 and default value.

UAC2[<umax>|DEFAULT] - Output voltage and default value phase 2

Adjusts output voltage of phase 2 and default value. Command has no effect on single-phased devices.

UAC3[<umax>|DEFAULT] - Output voltage and default value phase 3

Adjusts output voltage of phase 3 and default value. Command has no effect on single-phased devices.

UDC[<umax>|DEFAULT] - Output voltage and default value

Setting the DC offset. If no parameter is entered, the current setpoint is displayed. In three-phase devices, the voltage for all three phases is set simultaneously.

This command saves the default value permanently.

Example:

UDC -> (without parameter) returns the current set value
 UDC,90 -> The DC voltage is set to 90 VDC
 UDC,DEFAULT -> Current DC offset voltage is stored as default value

If the device is switched on in the future, the digital interface is initialized with (in this example) 90VDC output voltage

UDC1[<umax>|DEFAULT] - Output voltage and default value phase 1

Adjusts the dc offset for phase 1 and default value.

UDC2[<umax>|DEFAULT] - Output voltage and default value phase 2

Adjusts the dc offset for phase 2 and default value. Command has no effect on single-phased devices.

UDC3[<umax>|DEFAULT] - Output voltage and default value phase 3

Adjusts the dc offset for phase 3 and default value. Command has no effect on single-phased devices.

WAV[,MEM1|MEM2|MEM3|OUT]} - Output signal

Loads a user-defined wave. The parameter defines where the wave ends. The loading (MEM1 – MEM3) takes about 170ms time.

Beispiel:

WAV,MEM1 Memory location: Memory 1
 WAV,MEM2 Memory location: Memory 2
 WAV,MEM3 Memory location: Memory 3
 WAV,OUT Output, no save of the settings

Color marked lines represent the answer from the device.

The ends of the wave MEM1, MEM2 and MEM3 will be saved. This behavior is useful, if often used waves shall be saved for later purpose. The command **OUT** sends the data directly to the output of the device.

Direct mode must be activated with the command **WAVE,7**. After a blackout or if another wave form was selected, the data is lost. The command is followed by 3600 numerical values from 1.0 to -1.0. The value 1.0 corresponds the maximum positive voltage and the value -1.0 corresponds the maximum negative voltage. If the data was transferred successfully, the bit 4 is set within the status byte. This bit will be deleted immediately after the status byte was read out.

Example:

GTR Remote control
 WAVE,7 Direct mode
 WAV,OUT New wave shall be written to the output.
 0.000 First value 0 % of U_{max}
 0.100 Second value 0,1 % of U_{max}
 0.200 Third value 0,3 % of U_{max}

STATUS	Status byte query
STATUS,0000011100011001	Bit 4 is set → transmission successful
UAC,10%	Output voltage 10 % of the maximum value
IA,1	Output current 1 A
SB,R	Output active

Colour marked lines represent the answer from the device.

WAVE[,<Nr.>]

Adjusts the wave form. Parameters indicate the wave form. Parameters may be entered as number or text. Entering the command without parameters displays actual setting.

Table: Function of parameters

Parameter	Function
0	External, External input
1	Sine
2	Square
3	Triangle
4	Memory 1
5	Memory 2
6	Memory 3
7	Direct-Mode

12 EXTERNAL CONTROL: GPIB (OPTION / IEEE)

The address of the device is adjusted with DIP switches **1** to **5**. Addresses from 1 to 30 can be defined. The address of the device is set binary coded. The value for switch **1** is 1, for switch **2** it is 2, for switch **3** it is **4**, and so on. If the switch is in position **ON**, the assigned bit has the value 1, in position **OFF** the assigned bit has the value 0.

Example: Adjustment for device address 6

6 = 4 + 2 → Switch **3** (value 4) and switch **2** (value 2) must be in position **ON**.
Switches **5,4** and **1** are in position **OFF**, therefore they have the value 0.

Table: Device equipment (IEEE-488.1 conform)

SH1	Source handshake function available
AH1	Acceptor handshake function available
T6	Talker, Serial Poll, addressing via MLA
L4	Listener function, addressing via MTA
SR1	Service request function available
RL1	Remote/Local function available
PP0	no parallel poll function
DC1	Device Clear function available
DT0	no Trigger function
C0	no Controller function
E1	Open-Collector driver

Additional commands:

Command	Result
STB*STB?	Read status byte. Return value: STB, XXXXXXXX
*ESR?	Read or delete ESR register. Return value: ESR, XXXXXXXX
*ESE?	Read ESE register. Return value: ESE, XXXXXXXX
*SRE?	Read or delete SRE register. Return value: SRE, XXXXXXXX

Pin assignment IEEE socket:

LOG.GND	24	12	SHIELD
GND11	23	11	ATN
GND10	22	10	SRQ
GND9	21	9	IFC
GND8	20	8	NDAC
GND7	19	7	NRFD
GND6	18	6	DAV
REN	17	5	EOI
DIO8	16	4	DIO4
DIO7	15	3	DIO3
DIO6	14	2	DIO2
DIO5	13	1	DIO1

STATUS WORD

The status word is read out with the command `<STB>` or `<*STB?>`. Return value: STB,xxxxxxx

Table: Readout status word

Bit	Function
D7	no function
D6	SRQ set if SRQ was requested
D5	ESB set if a byte in the SES register was set
D4	MAV set if a message is available
D3	see table
D2	see table
D1	see table

D0	see table
----	-----------

Table: Error Messages

D3	D2	D1	D0	Error
0	0	0	1	Syntax
0	0	1	0	Command
0	0	1	1	Range
0	1	0	0	Unit
0	1	0	1	Hardware
0	1	1	0	Read

12.1 SES-REGISTER - STANDARD EVENT STATUS REGISTER (SES)

The IEEE-488.1 norm demands the standard event status register (SES).

Bit	Function
D7	Power on
D6	Command Error
D5	User Request (not used by software)
D4	Execution Error
D3	Device dependent Error
D2	Query Error
D1	Request Control (not used by software)
D0	Operation complete

13 RS232 INTERFACE (OPTION))

To connect the RS232 interface, a crossover cable must be used.

The baud rate of the RS232 interface can be adjusted with the command `<PC>`. If the actual setting of the device is unknown, the DIP switches **1-5** can be set to position **ON** with the effect that afterwards the interface is setup to 9600,n,8,1 Adr 30 (9600 baud, no parity, 6 data bits, 1 stop bit). Afterwards, a new setup may be programmed.

After reprogramming the device, the DIP switches **1-5** should be set to their original start or at least one switch should be left in position **ON**, the others in position **OFF**. After sending the command `<PC>` and adjusting the parameters, the

settings are active. From now on, every command with new PC settings must be sent. To keep the changes after switching the device off and on, they need to be saved with the command `<SS>`.

The status word is read out with the command `<STB>` or `<*STB?>`.

Table: Function of the bits

Bit	Function
D15	Parity Error
D14	Over Run Error
D13	Framing Error
D12	Timeout Error
D11	Echo On
D10	internally used, may be 1 or 0
D9	Hardware handshake (RTS/CTS)
D8	Software handshake (XON/XOFF)
D7	Parity enable
D6	Parity mode (1 = odd, 0 = even)
D5	Stop bit (1 = 2 stop bits; 0 = 1 stop bit)
D4	Data format (1 = 8 bit; 0 = 7 bit)
D3	internally used, may be 1 or 0
D2	see table: error messages
D1	see table: error messages
D0	see table: error messages

Table: Error messages

D2	D1	D0	Error
0	0	1	Syntax
0	1	0	Command
0	1	1	Range
1	0	0	Unit
1	0	1	Hardware
1	1	0	Read

Pin assignment RS232, D-SUB 9:

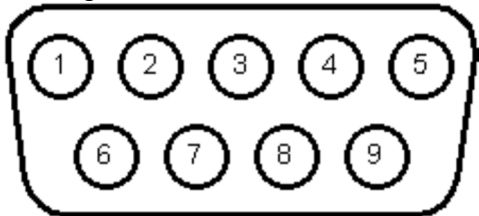

		5	COM (GND)
N.C.	9	4	N.C.
CTS	8	3	TxD
RTS	7	2	RxD
N.C.	6	1	N.C.

14 RS485 INTERFACE (OPTION)

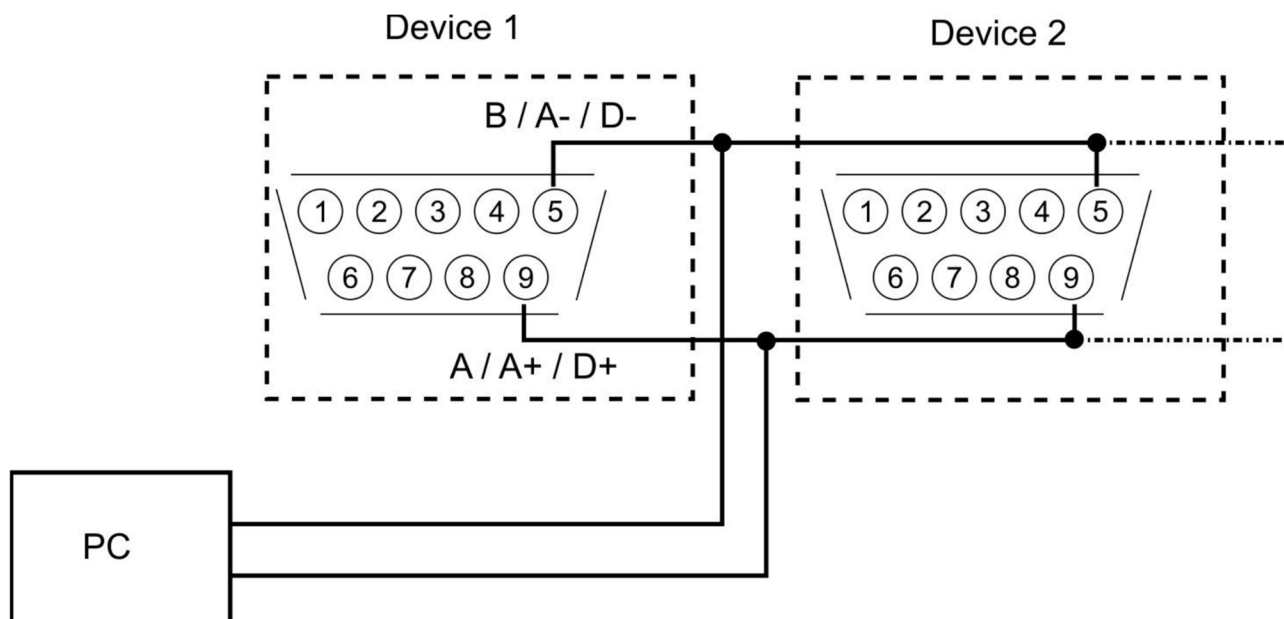

The connected device can be selected by placing the number of the device and a „#“ sign in front of the command. If the word „ALL“ is placed instead of the number of the device, the following command will be executed by all connected devices (e. g. #1, ID; #22, GTR, #ALL, GTL). The status word can be read out with the command <STB> or <*STB?>.

Table: Function of the bits

Bit	Function
D15	Parity Error
D14	Over Run Error
D13	Framing Error
D12	Timeout Error
D11	no function
D10	no function
D9	no function
D8	no function
D7	Parity enable
D6	Parity mode (1 = odd, 0 = even)
D5	Stop bit (1 = 2 Stop bits; 0 = 1 Stop bit)
D4	Data format (1 = 8 bit; 0 = 7 bit)
D3	no function
D2	see table
D1	see table
D0	see table

Table: Error messages

D2	D1	D0	Error
0	0	1	Syntax
0	1	0	Command
0	1	1	Range
1	0	0	Unit
1	0	1	Hardware
1	1	0	Read

A timeout between receiving a message and sending an answer can be programmed (see command <PR>). Interface parameters are configured with the software and the command <PCx> and they can be saved with the command <SS>.

14.1.1 Reconfiguration of the interface

In case, the user has forgotten the active setup, there are two ways of reconfiguring the interface:

- sending the command **<PR>** from one of the other interfaces
- bringing the DIP switches 1-5 in **ON** position with the effect that afterwards the interface is setup to 9600,n,8,1 Adr 30 (9600 baud, no parity, 8 data bits, 1 stop bit) - using a terminal program (adjusted to these parameters) with the command **<PR>** to reconfigure the interface

Pin assignment RS485, 3 pin connector:

1	2	3
A(Data +)	B(Data -)	GND

15 EXTERNAL CONTROL: ETHERNET (LAN) (OPTION)

To communicate with the EAC via network, it is necessary to assign an IP address to the device first. In delivery status, the device automatically draws an IP from the network. In its practical operation, this behavior is unfavorable, because the device has a new IP address after each activation. Therefore, to each device an individual, permanent IP address

should be assigned. The actual IP and MAC address can be requested via another interface with the command `<PL>`. Alternatively, an IP can be manually assigned to the device via network.

15.1 DETERMINATING THE IP USING THE DEVICE INSTALLER BY LANTRONIX

With the program Deviceinstaller, Lantronix offers a program to easily detect a device within the network. After executing the program and clicking the button *Search*, all XPORTS within the network are displayed. The current assigned (dynamical) IP will also be displayed. This IP can be entered in the address line of a browser. If you want to set a static IP Address use "Assign IP".

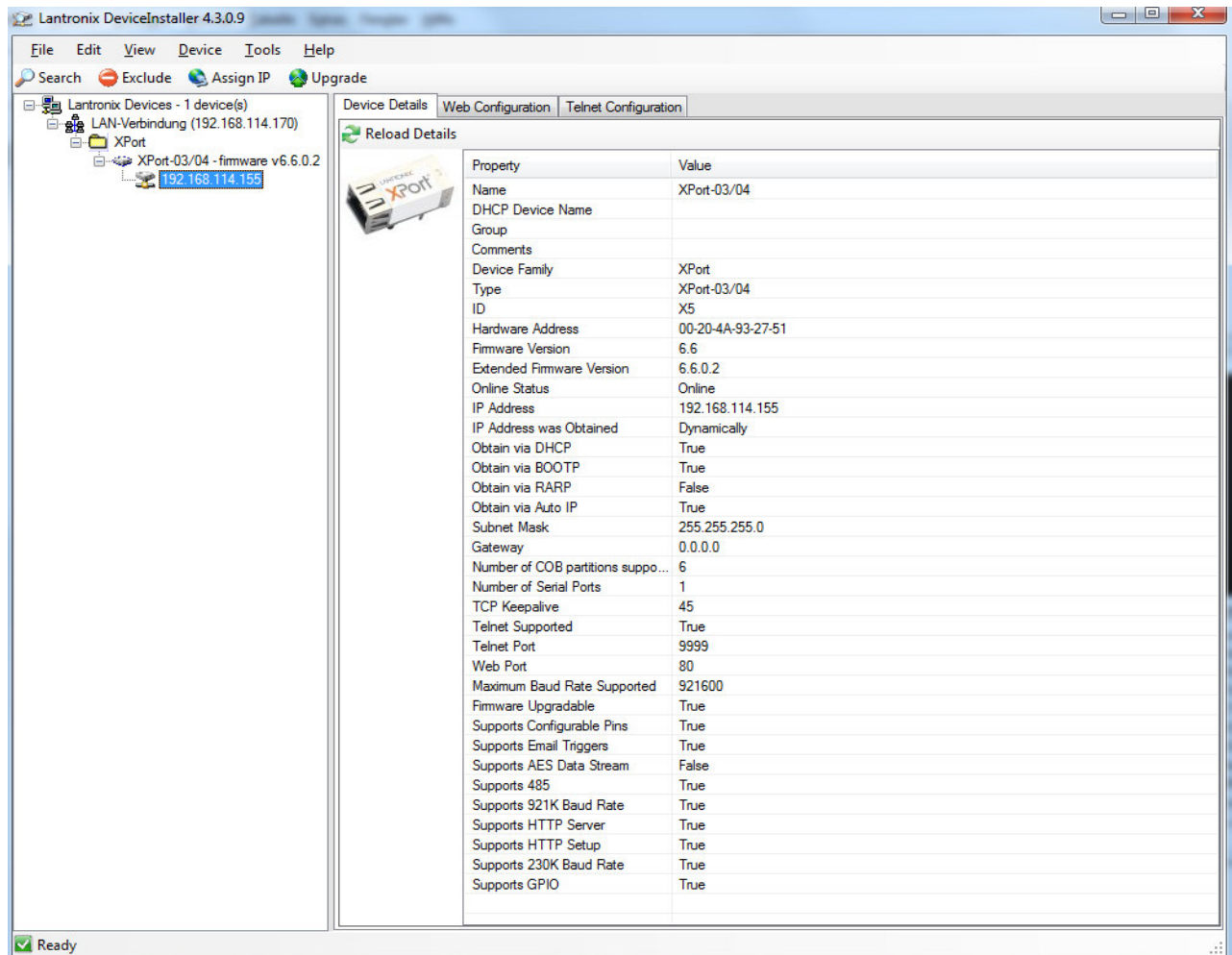

15.2 CONTROLLING THE DEVICE WITH TELNET

The device can be directly controlled via port 10001. After the console is opened, clicking on 'Start' and 'Ausführen' (execute) opens a DOS window. Afterwards the command `cmd` or `command` opens a DOS window: `telnet xxx.xxx.xxx.xxx 10001`. Alternatively, many terminal programs offer the possibility to establish a TCP/IP or telnet connection.



When controlling the device via port 10001, the user interface of the device must not be open in a browser!

TELNET CONNECTION WITH REALTERM

Realterm is a free OpenSource terminal program, which may be downloaded here: <http://realterm.sourceforge.net/>

After the program was installed and executed, the box *Half Duplex* must be checked within the tab *Display*.

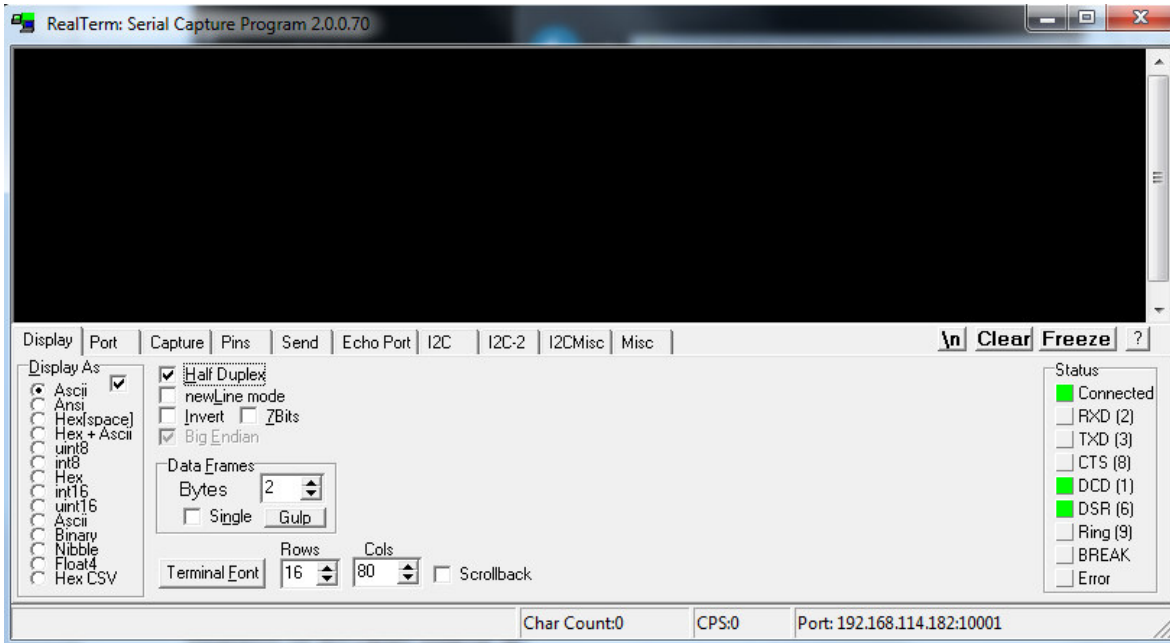

The IP address must be entered within the tab *Port* in the following format: xxx.xxx.xxx.xxx:10001. Afterwards the button *Open* must be clicked. In the terminal box the desired commands can be sent to the device.

16 EXTERNAL CONTROL: USB (OPTION)

A virtual COM port for a PC is provided by the USB interface of the unit. Using this port, the unit may be programmed as if using the RS232 interface. The driver for popular system software may be downloaded at: <http://www.ftdichip.com/Drivers/VCP.htm>.

The status word can be read out with the command `<STB>` or `<*STB?>`.

Table: Function of bits

Bit	Function
D15	Parity Error
D14	Over Run Error
D13	Framing Error
D12	Timeout Error
D11	Echo On
D10	used internally used, may be 1 or 0
D9	Hardware handshake (RTS/CTS)
D8	Software handshake (XON/XOFF)
D7	Parity enable
D6	Parity mode (1 = odd, 0 = even)
D5	Stop bit (1 = 2 stop bits; 0 = 1 stop bit)
D4	Data format (1 = 8 bit; 0 = 7 bit)
D3	used internally, may be 1 or 0
D2	see table: error messages
D1	see table: error messages
D0	see table: error messages

Table: Error messages

D2	D1	D0	Error
0	0	1	Syntax
0	1	0	Command
0	1	1	Range
1	0	0	Unit
1	0	1	Hardware
1	1	0	Read

The defined character for XON is 0 x 11. The defined character for XOFF is 0 x 13.

The interface parameters can be configured with the command `<PU>` and then be saved with the command `<SS>`.

16.1.1 Reconfiguration of the interface

In case, the user has forgotten the active setup, there are two ways of reconfiguring the interface:

- sending the command `<PU>` from one of the other interfaces
- bringing the DIP switches 1 to 5 in **ON** position with the effect that afterwards the interface is setup to 9600,n,8,1,Adr 30 (9600 baud, no parity, 8 data bits, 1 stop bit) - using a terminal program (adjusted to these parameters) with the command `<PS>` to reconfigure the interface

17 DATA LOG FUNCTION (OPTION SD-CARD))

The device possesses a data log function. A memory card may be used as data logger. All measure values will be saved, separated by tabulators, in a text file. The time interval may be adjusted from 1-4294967 s (= 71 minutes). To activate the data log function, a memory card must be inserted. The root directory of the memory card must contain a text file named „EACLOG.txt“. The new data will be written into this file.



The memory card must be inserted or removed in standby mode only!

In case, that the first entry of the first line of the file is "interval=xxxx" (xxxx = time in seconds), the memory interval is adjusted accordingly. The entry must be written in lower case letters and without space characters. If the interval remains unspecified, the memory interval is 60 seconds.

Example:

```
interval=30
```

The data log function is active whenever the device is not operating in standby mode. The function is indicated by a small memory card symbol in the upper right corner of the main display. Whenever a new data set is written, the symbol will be displayed as filled for ca. 1 second. In case the memory card is full, the symbol will be crossed out.

17.1 DATA FORMAT OF THE SAVED DATA

The first entry shows the actual operation mode. The second entry shows the actual operation status, followed by U_{eff} , U_{dc} , U_{max} , I_{eff} , I_{dc} , I_{max} , P and Frq .

Example: Single-phased device

```
Run      230,0   0,0      325,3   1,000   0,000   1,414   230,00   50,0
```

18 SCRIPT MODE (OPTION SD-CARD)

Operation sequences may be programmed in a script, which can be read in from a memory card. A script is a text file, which includes a sequence of commands. The device is able to process up to 100 commands.

18.1 EXECUTING/LOADING A SCRIPT

The script mode can be activated by pushing the button **User Memory** twice. The option script can be selected from the data item menu using the rotary pulse encoder **Frequency/Select**. The option can be selected using the button **User Memory**.

The desired file can be selected by rotating and then pressing the rotary pulse encoder **Frequency/Select** ("Load Script ok" appears in the display). To switch to normal mode, the button **Frequency/Select** (or **Display**) must be pressed once. The name of the loaded file appears on the lower left corner of the display. The script can be started by pushing the button **Standby Local**.

If the memory card was removed in "Standby" mode and the device needs to be programmed again, the rotary pulse encoder **Frequency/Select** must be pushed.

Example: Simulating a phase failure for 2.5 seconds with a repetition rate of 1 minute

```
; Phasenausfall:
;
sine          ;UI mode
Ua 10.0       ;Voltage 10V
Iac 2         ;Output current 2A
```

```

Idc 0          ;no DC portion
RUN           ;Output active
LOOP         ;Loop address at the end of the script
delay 60      ;60s pause
Iac 0         ;Output current 0A
delay 2.5     ;2.5s pause
Iac 2         ;Output current 2A
; End of the script, processing continues at LOOP

```

18.2 COMMANDS

18.2.1 Syntax

Upper and lower case are no relevant. Therefore, the following commands deliver the same results: *P*MAX 100 *P*max 100 *p*MaX 100. Delimiters must be placed between two commands or between command and parameter. Valid delimiters are: blank, tabulator, LineFeed <LF>, Carriage Return <CR> and equal sign (=).

Numerical values must be placed as basic units and may not be followed by characters. Valid delimiters for decimal places are: point and comma. No characters must be attached: U 12,345 U 10.00 U 12. The command UAC 12.114V is invalid, because it is followed by a character.

All commands may be written consecutively, but must be separated by blanks: U 10 I 1 UIP LOOP RUN. Due to its unclear syntax, this style is not recommendable.

18.2.2 Quick view of commands

Command	Description	Result	U mode	I mode
; or #	comment	Entering commented text.	X	X
DELAY<t>	delay	Delays execution of the script for duration of time t. DELAY 1 waits 1 second DELAY 0.012 waits 12 mill second	X	X
DIP <t>	Output Standby	Switches the output signal for the specified with t	X	X

Command	Description	Result	U mode	I mode
		Time off. t is in seconds with digits after the decimal point (E.g. 0.013 13ms)		
EXTERN		External input.	X	X
FRQ	frequency [Hz]	Adjusts the output frequency.	X	X
IA	current [A]	Adjusts the set point of the output current.	X	
IA1	current [A]	Adjusts the set point of the output current for phase 1.	X	
IA2	current [A]	Adjusts the set point of the output current for phase 2.	X	
IA3	current [A]	Adjusts the set point of the output current for phase 3.	X	
IAC	current [A]	Adjusts the set point of the output current.		X
IAC1	current [A]	Adjusts the set point of the output current for phase 1.		X
IAC2	current [A]	Adjusts the set point of the output current for phase 2.		X
IAC3	current [A]	Adjusts the set point of the output current for phase 3.		X
IDC	current [A]	Adjusts the set point of the DC output current.		X
IDC1	current [A]	Adjusts the set point of the DC output current for phase 1.		X
IDC2	current [A]	Adjusts the set point of the DC output current for phase 2.		X
IDC3	current [A]	Adjusts the set point of the DC output current for phase 3.		X
LOOP	loop	Defines the loop address.	X	X
LOOPCNT<number>	Return loop with number of loops	As LOOP but counted. LOOPCNT 10 return is limited to 10 loops	X	X
MEM1		Output wave form memory 1. The loading (MEM1 – MEM3) takes about 170ms time.	X	X
MEM2		Output wave form memory 2. The loading (MEM1 – MEM3) takes about 170ms time.	X	X
MEM3		Output wave form memory 3. The loading (MEM1 – MEM3) takes about 170ms time.	X	X
NOSYNC		Deactivates the sync input.	X	X
PHASE	Phasen shifting [degree]	Phase shifting towards reference sine.	X	X
PHASE1	Phasen shifting [degree]	Phase shifting of phase 1 towards reference sine.	X	X
PHASE2	Phasen shifting [degree]	Phase shifting of phase 2 towards reference sine.	X	X
PHASE3	Phasen shifting [degree]	Phase shifting of phase 3 towards reference sine.	X	X
RECT		Output wave form rectangle.	X	X
RUN		Reset the standby function.	X	X
SINE		Output wave form sine.	X	X
STANDBY		Standby	X	X
SYNC		Activates the sync input.	X	X
SYNVWAVE	Synchronize sine	Waiting for sync to the internal sine.	X	X
TRIANGLE		Output wave form triangle.	X	X
UA	U_{eff} [V]	Set value of the output voltage.		X
UA1	U_{eff} [V]	Set value of the output voltage for phase 1.		X
UA2	U_{eff} [V]	Set value of the output voltage for phase 2.		X
UA3	U_{eff} [V]	Set value of the output voltage for phase 3.		X
UAC	U_{eff} [V]	Set value of the AC output voltage.	X	
UAC1	U_{eff} [V]	Set value of the AC output voltage for phase 1.	X	
UAC2	U_{eff} [V]	Set value of the AC output voltage for phase 2.	X	
UAC3	U_{eff} [V]	Set value of the AC output voltage for phase 3.	X	
UDC	U_{dc} [V]	Set value of the DC output voltage.	X	
UDC1	U_{dc} [V]	Set value of the DC output voltage for phase 1.	X	
UDC2	U_{dc} [V]	Set value of the DC output voltage for phase 2.	X	
UDC3	U_{dc} [V]	Set value of the DC output voltage for phase 3.	X	
WAIT	Wait on user action	Wait on press "SYNC", the "SYNC" LED is flashing	X	X

18.2.3 Detailed description of commands

; or # - Comment

Comment on text. All characters from ; or # up to end of line will be ignored. This function is not available when programming via digital interface.

Example:

```
# This is a comment
SYNC # This command activates the sync mode
; Comments can also start with a semicolon
```

DELAY - Time delay

The command **DELAY** delays the execution of the script. The following number defines the duration of the delay in ms (milliseconds). Maximum duration of delay is 65535 ms or 65535 s.

Example:

```
UA 100      # Output voltage 100 V
IAC 10      # Output current 10 A
RUN         # Output active
DELAY 1     # wait 1 s
STANDBY     # Deactivate output
```

If set in the Example DELAY 0.012 it waits 12 millisecond

DIP <t>

Disconnects the output signal for the t specified time t is in seconds with digits after the decimal point (E.g. 0.013 13ms)

Exampel:

```
# Disconnect output at different Phase degrees
ia 5      # Output current 5A
frq 50    # Output frequency 50Hz
run       # Enable output
uac 200   # Output voltage 200V
wait     # Wait on user action
dip 0.01  # Output standby for 10ms. Start at 0°
delay 0.2 # Delay 200ms
phase 90  # Phase angle 90° to the internal reference
wait     # Wait on user action
dip 0.01  # Output standby for 10ms. Start at 90°
delay 0.2 # Delay 200ms
phase 180 # Phase angle 180° to the internal reference
wait     # Wait on user action
dip 0.01  # Output standby for 10ms. Start at 180°
delay 0.2 # Delay 200ms
phase 270 # Phase angle 270° to the internal reference
wait     # Wait on user action
dip 0.01  # Output standby for 10ms. Start at 270°
delay 0.2 # Delay 200ms
phase 0   # Phase angle 0° to the internal reference
wait     # Wait on user action
dip 0.11  # Output standby for 110ms.
delay 0.2 # Delay 200ms
```

EXTERN - Output wave form

Selects the output wave form.

FRQ - Frequency

Adjusts the output frequency in Hz.

IA, IA1, IA2, IA3 - Set value output current

Adjusts the set point for the output current in ampere. The commands **<IA>** and **<IA1>** have the same effect. The commands **<IA2>** and **<IA3>** have no effect on single-phased devices. On three-phased devices, the command **<IA>**

adjusts the current for all three phases. The commands **<IA1>**, **<IA2>** and **<IA3>** adjust the set value of the output current for each phase.

IAC, IAC1, IAC2, IAC3 - Set value AC output current

Adjusts the AC set point for the output current in ampere. The commands **<IAC>** and **<IAC1>** have the same effect. The commands **<IAC2>** and **<IAC3>** have no effect on single-phased devices. On three phased devices, the command **<IAC>** adjusts the current for all three phases. The commands **<IAC1>**, **<IAC2>** and **<IAC3>** adjust the set value of the AC output current for each phase.

IDC, IDC1, IDC2, IDC3 - Set value DC output current

Adjusts the DC set point for the output current in ampere. The commands **<IDC>** and **<IDC1>** have the same effect. The commands **<IDC2>** and **<IDC3>** have no effect on single-phased devices. On three phased devices, the command **<IDC>** adjusts the current for all three phases. The commands **<IDC1>**, **<IDC2>** and **<IDC3>** adjust the set value of the AC output current for each phase.

LOOP - Return Loop

Usually the script ends with the last command. A return address can be defined with the command **<LOOP>**. From this point on, the processing will continue after the last command of the script. To interrupt the program, button **Standby Local** must be pushed.

Example:

```
# This example adjusts an output current of 1 A.
# The output current is activated and deactivated every second.
UA 100      # Output voltage 100 V
IAC 1       # Output current 1 A
LOOP        # Return address
RUN         # Activate output
DELAY 1.0   # Wait 1 s
STANDBY     # Deactivate output
DELAYS 1.0  # Wait 1 s
```

LOOPCNT <cnt> Return loop with number of loops

It like command LOOP but counted by number <cnt>. The maximum number is 65535.

MEM1, MEM2, MEM3 - Output wave form

Adjusts the output wave form for memory 1, memory 2 and memory 3. The loading (MEM1 – MEM3) takes about 170ms time.

NOSYNC - Deactivate sync input

Deactivates the sync input.

18.2.3.1 PHASE, PHASE1, PHASE2, PHASE3 - Adjust phasing

Adjusts the phasing towards the internal reference sine. The value is in degree. The commands **<PHASE2>** and **<PHASE3>** have no effect on single-phased devices. The commands **<PHASE>** and **<PHASE1>** have the same effect. On three-phased devices, the command **<PHASE>** adjusts the phase shifting for all three phases. The commands **<PHASE1>**, **<PHASE2>** and **<PHASE3>** adjust the phase shifting for each phase.

RECT - Output wave form rectangle

Adjusts the output wave form rectangle.

RUN - Reset standby mode

The command **RUN** resets the standby mode.

Example:

RUN # Activates the output

SINE - Output wave form sine

Adjusts the output wave form sine.

STANDBY - Activate standby mode

The command **STANDBY** activates the standby mode.

Example:

STANDBY # Deactivates the output

SYNC - Activate sync input

Activates the sync input.

SYNCWAVE

Waiting for sync to the internal reference sine.

Example:

```
#Here is alternately by 200V/20V with a duration pulse packets of each
#produces 100 ms. This is synchronous, so that the pulse packets always
#have the same number of periods
ia 5 # Output current 5A
frq 50 # Output frequency 50Hz
run # Enable output
loop # Loop line
syncwave # Sync to the internal reference.
uac 200 # Output voltage 200V
DELAY 0.110 # Delay 110ms
uac 20 # Output voltage 20V
syncwave # Sync to the internal reference.
DELAY 0.075 # Delay 75ms
```

It is to note that the SYNCWAVE command waits for the zero crossing of the internal reference sine. Then the script continues to run, so that E.g. a delay command from this date begins with the delay.

So for example one is changes to the output signal always at the beginning of the internal reference sine effectively, voltage change after a SYNCWAVE command will only take effect after a period.

TRIANGLE - Output wave form triangle

Adjusts the output wave form triangle.

UA, UA1, UA2, UA3 - Set value output voltage

Adjusts the set value for the output voltage in volt. The commands **<UA>** and **<UA1>** have the same effect. The commands **<UA2>** and **<UA3>** have no effect on single-phased devices. On three phased devices, the command **<UA>** adjusts the voltage for all three phases. The commands **<UA1>**, **<UA2>** and **<UA3>** adjust the voltage limitation of the output voltage for each phase.

UAC, UAC1, UAC2, UAC3 - Set value AC output voltage

Adjusts the AC set value for the output voltage in volt. The commands **<UAC>** and **<UAC1>** have the same effect. The commands **<UAC2>** and **<UAC3>** have no effect on single-phased devices. On three phased devices, the command **<UAC>** adjusts the voltage for all three phases. The commands **<UAC1>**, **<UAC2>** and **<UAC3>** adjust the set value of the output voltage for each phase.

UDC, UDC1, UDC2, UDC3 - Set value DC output voltage

Adjusts the DC set value for the output voltage in volt. The commands **<UDC>** and **<UDC1>** have the same effect. The commands **<UDC2>** and **<UDC3>** have no effect on single-phased devices. On three phased devices, the command **<UDC>** adjusts the voltage for all three phases. The commands **<UDC1>**, **<UDC2>** and **<UDC3>** adjust the set value of the output voltage for each phase.

WAIT On "Sync-Taste press" waiting

If the script needs a user action, the sync LED flashes.

Example:

```
#In this example, the output voltage on 200V is set.  
# When the user presses the sync button, the output voltage will be  
# interrupted for 1 period  
ia 5      # Output current 5A  
frq 50    # Output frequency 50Hz  
run       # Enable output  
loop      # Loop line  
uac 200   # Output voltage 200V  
wait      # Wait on user action  
dip 0.02  # Delay 20ms
```

19 APPENDIX

All files described in the following examples are available on request at ET System electronic.

19.1 GENERATING USER-DEFINED WAVES

19.1.1 Introduction

The .wav format is part of the Resource Interchange File Format (RIFF). This format is a container format to save multimedia data and streams for Windows® operating systems. The body of this format is used to save user-defined wave forms with the EAC-S, while for use with the EAC-S only the .wav format is relevant.

A full-wave consists of 3600 sampling points. Each sampling point is a signed 16 bit value.

There are two ways to create a wave file applicable to the EAC-S device. The easiest way is the use of a wave editor. Another possibility, which is especially interesting for technical applications, is to export a wave file from a circuit simulation software. If the desired data is numerical, the use of a macro for a spread sheet software is recommended. All possibilities mentioned here will be described in the following chapters.

19.1.2 Creating a .wav file

The body of a wave file is not necessarily required for its usage. The information might be useful though for the creation of user-defined converters or macros. Therefore the file format is described here.

Format of a wave file:

Memory sequence: LSB first

uint16: LSB, MSB

uint32: LSB, Byte2, Byte3, MSB

Offset	Size	Name	Function	Value at EAC-S
1.RIFF header:				
0x00	uint32	ChunkID	Identifier („RIFF“)	„RIFF“
0x04	uint32	ChunkSize	File size <file length-8>	0x00001c44
0x08	uint32	Format	Identifier („WAVE“)	„WAVE“
2.fmt chunk				
0x0c	uint32	Subchunk1ID	Identifier („fmt“)	„fmt“ (regard space character!)
0x10	uint32	Subchunk1Size	Length of fmt-chunk	0x00000010 (= 16 bytes)
0x14	uint16	AudioFormat	1 = Linear PCM	0x0001
0x16	uint16	NumChannels	Number of audio channels	0x0001 (= 1 channel)
0x18	uint32	SampleRate	Sample rate (Sample/s)	0x002bf20 ¹
0x1c	uint32	ByteRate	$==\text{SampleRate} * \text{NumChannels} * \text{BitsPerSample}/8$	0x00057e40 ²
0x20	uint16	BlockAlign	Number of bytes for a complete sample of all channels ($=\text{NumChannels} * \text{BitsPerSample}/8$)	0x0002 (=2 bytes)
0x22	uint16	BitsPerSample	e. g.. 8 or 16	0x10 (=16 Bit)
3.data chunk:				
0x24	uint32	Subchunk2ID	Identifier („data“)	„data“
0x28	uint32	Subchunk2Size	Length of data-chunk ($=\text{NumSamples} * \text{NumChannels} * \text{BitsPerSample}/8$)	0x00001c20 (=7200 bytes, = 3600 samples * 2 byte/sample)
0x2c	???	data	Audio data	7200 Bytes

Example: Dump of the header

```
0000h: 52 49 46 46 44 1C 00 00 57 41 56 45 66 6D 74 20
0010h: 10 00 00 00 01 00 01 00 20 BF 02 00 40 7E 05 00
0020h: 02 00 10 00 64 61 74 61 20 1C 00 00 dd dd dd dd...
(dd → Wave-Data)
```

19.1.3 Creating a .wav file with SwitcherCAD (Linear Technology)

SwitcherCAD is free circuit simulation software by Linear Technology which may be downloaded from the Linear Technology homepage: <http://www.linear.com>. There are also further details and license agreements for software usage can also be found there.

¹ Since the EAC-S always uses the first 3600 samples, the sample rate is not important.

² Byte rate at the EAC-S is usually = 2 x SampleRate

A wave file can be exported from a simulated wave using SwitcherCAD. In the following example, this function is used to generate a wave form for EAC-S. For building a .wav file, LTSpice uses the Spice directive .wave.

Syntax

.wave <filename.wav> <Nbits> <SampleRate> V(out)

<filename.wav>	absolute path to wave file
<Nbits>	data rate (= 16 bit for the EAC-S)
<SampleRate>	sample rat in bit/s
V(out)	signal, which is to be saved

The data rate for EAC-S is 16 bit. The first channel (stereo: audio-L) will always be resumed on a wave file with multiple channels. The EAC-S uses the first 3600 samples.

Example:

Cycle duration of the signal is 20ms (=50Hz).
A cycle is to be saved.
SampleRate = 3600 / 20ms = 180 kHz = 180000
.wave C:\test.wav 16 180000 V(n001)

LTSpice scales the data to 1 V respectively 1 A. The range of the file corresponds to + 1 V up to - 1 V or + 1 A up to - 1 A. To use the dynamics of the EAC-S to full capacity, this range should be used. The example wave_out.asc uses the full capacity by transforming the measuring voltage with a voltage-controlled power supply in the corresponding measurement range.

Building and uploading a wave file for EAC-S:

The circuit (wave_out.asc) must be loaded in SwitcherCAD. To start the simulation the button **RUN** must be pushed (alternatively: select "Run" from the menu "simulate"). SwitcherCAD generates the file test.wav and saves it to directory C:\. The file must be copied from C:\test.wav to a MMC or SD memory card. Afterwards the memory card must be inserted to the EAC-S. The button **User Memory** must be pushed twice before the desired memory location (memory 1-3) can be selected from the item menu. Pushing the button **Save Recal** opens the file menu of the memory card. After the file "test.wav" was selected, the rotary pulse encoder **Frequency/Select** must be pushed. The file is saved and may be selected like a standard wave form by using the button **User Memory**.

19.1.4 Creating, editing and loading a .wav file with a wave editor

There are several wave editors to create applicable files for the EAC-S. In the following example, the free wave editor „Audacity“ was used. This software is available for several operating systems. For more information check <http://audacity.sourceforge.net/>.

Adjusting the frequency of the project

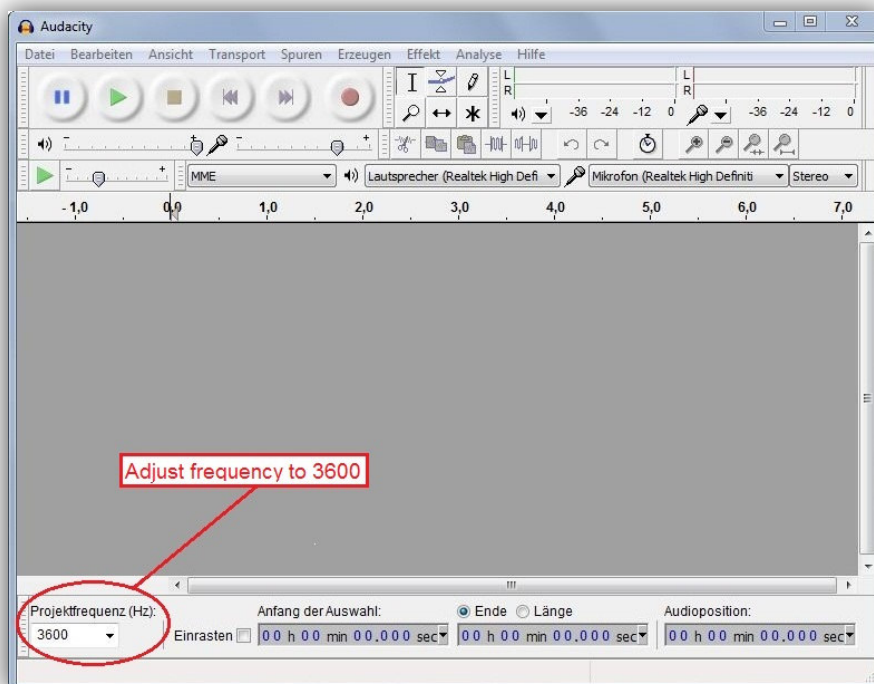

Adding the 1. soundtrack

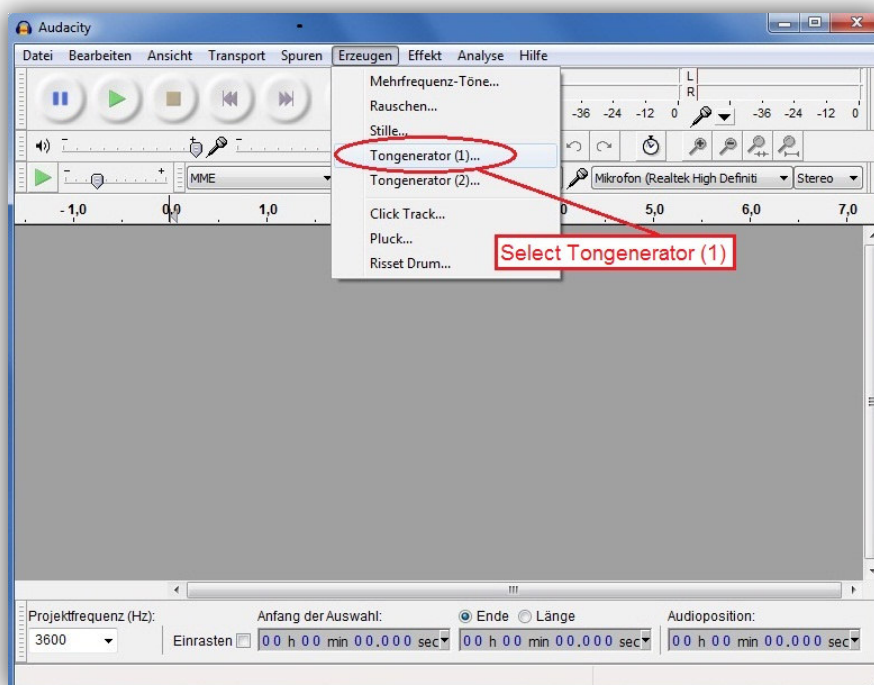

Entering values in the soundtrack editor

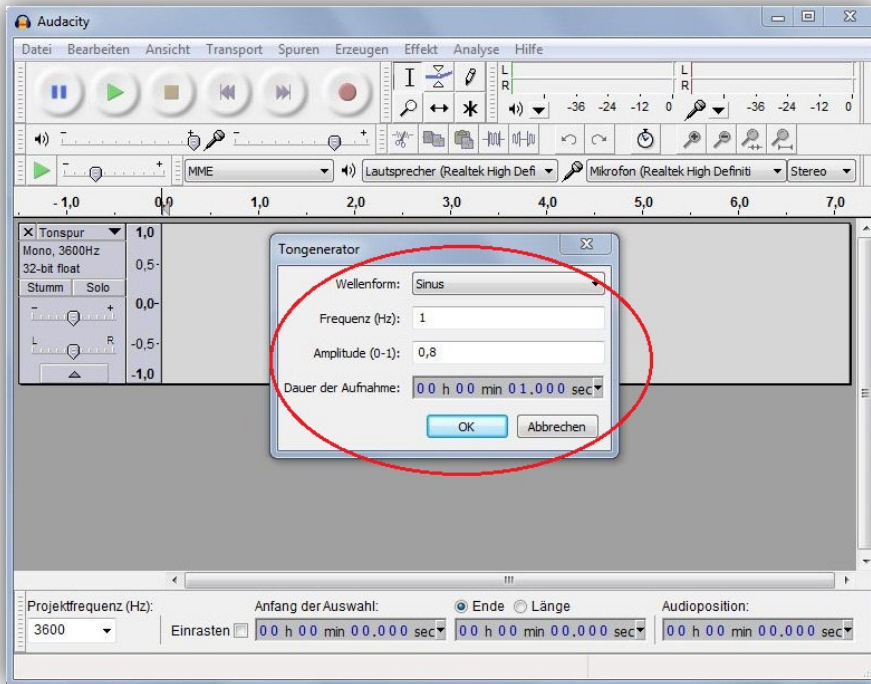

Unselecting the new soundtrack

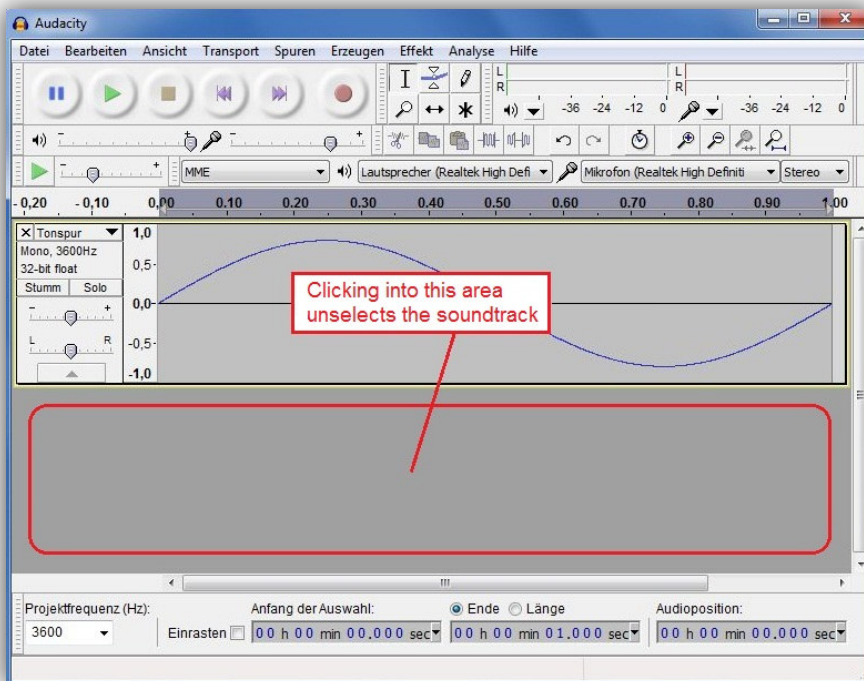

Adding the 2. soundtrack

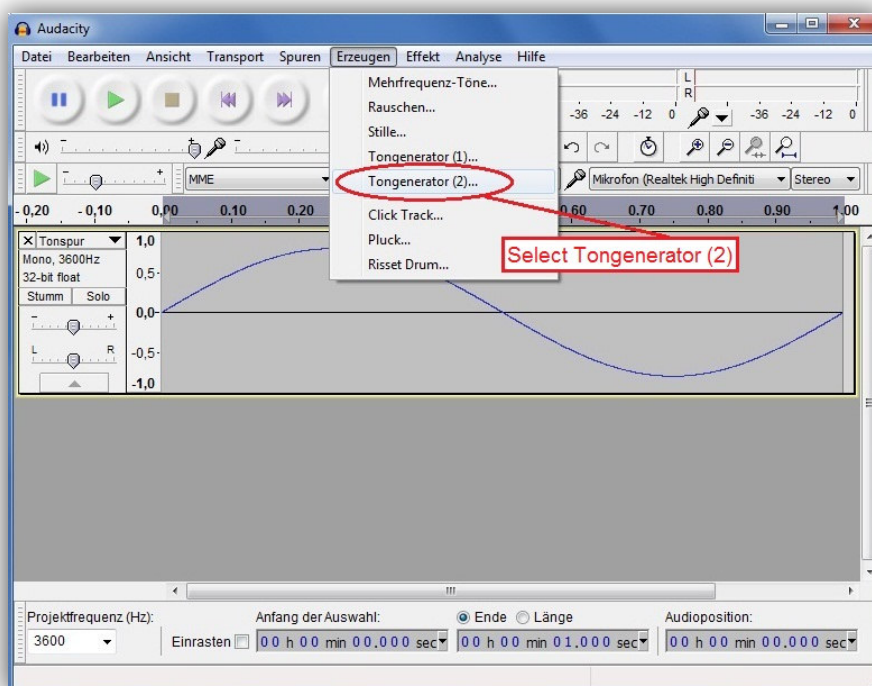

Entering values in the soundtrack editor

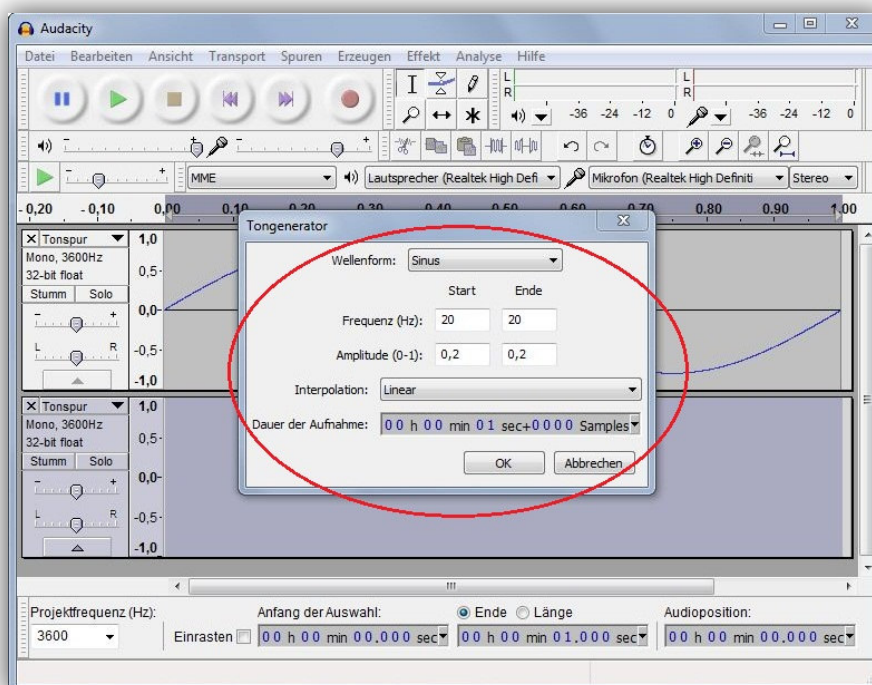

Unselecting the new soundtrack

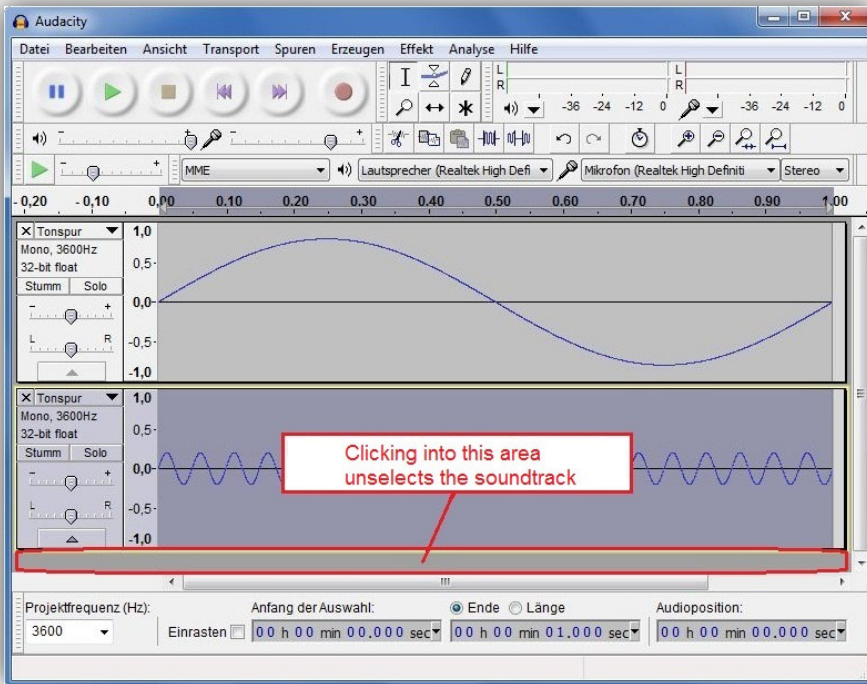

Combining the soundtracks

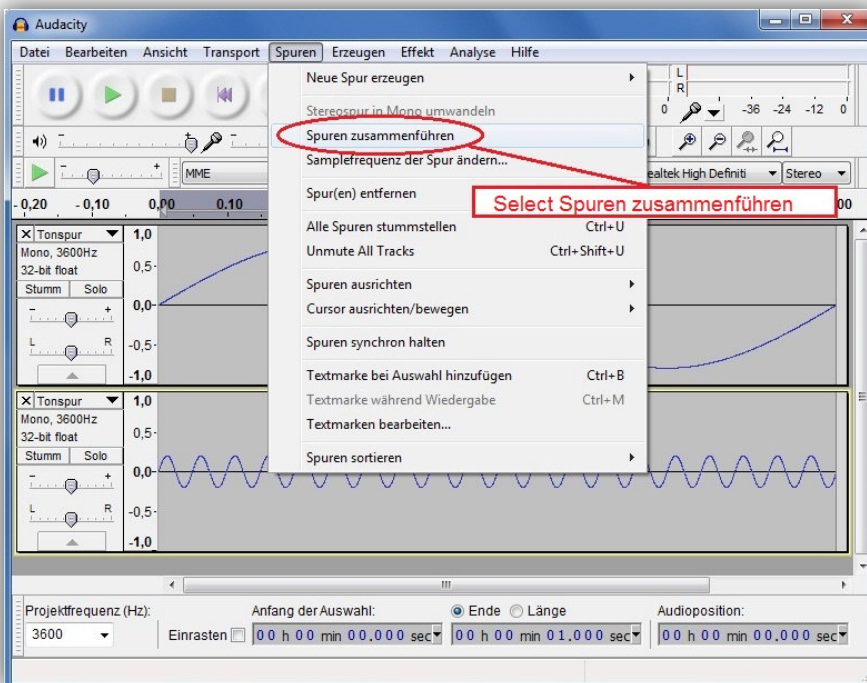

Combined soundtracks

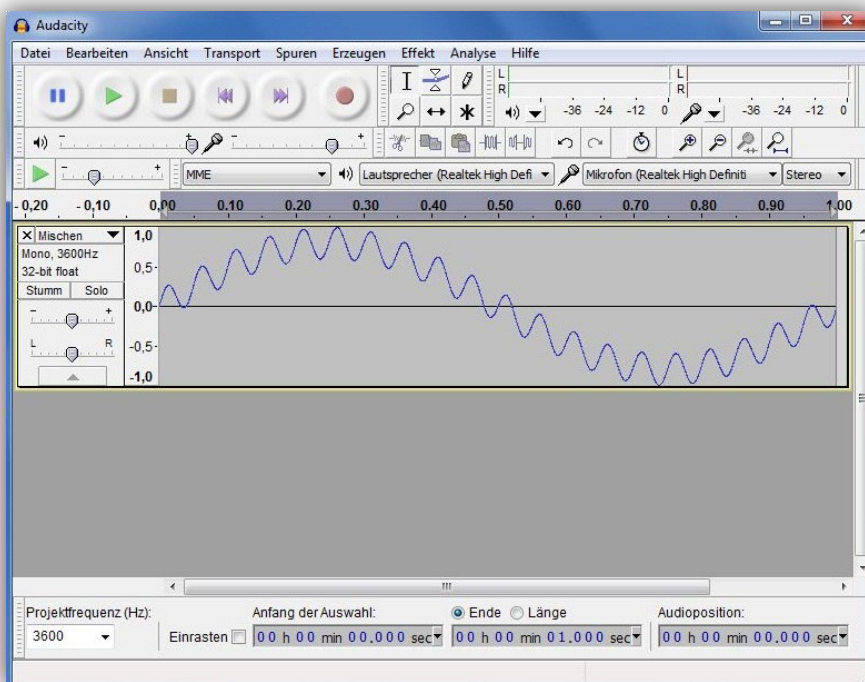

Selecting the sample format

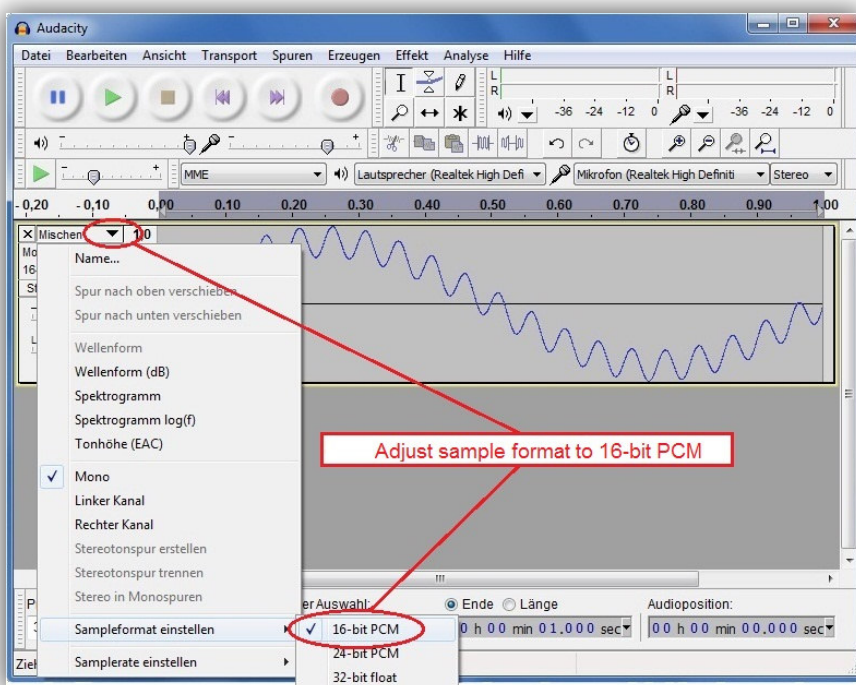

Exporting the samples

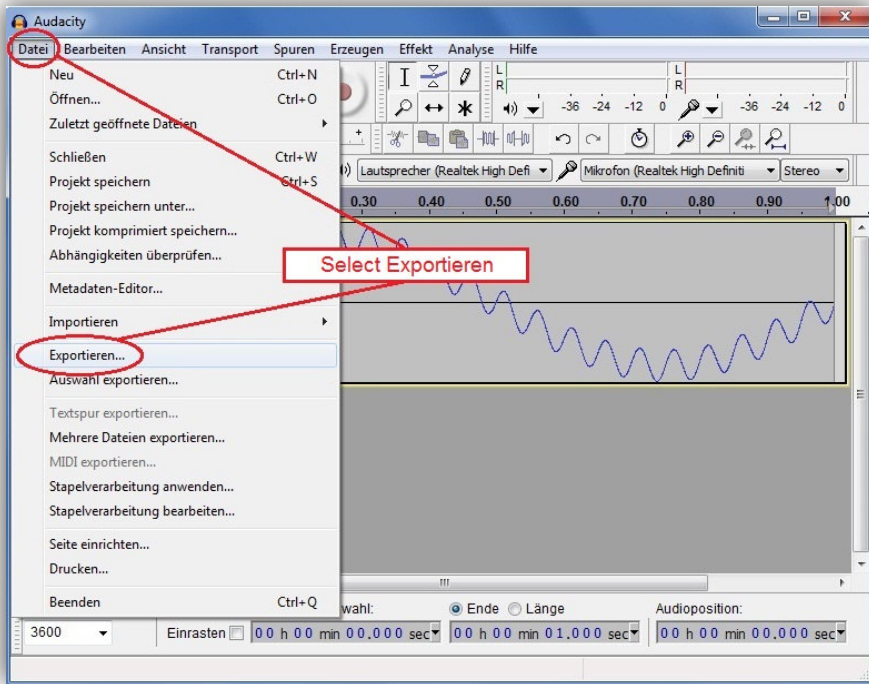

Selecting the memory location

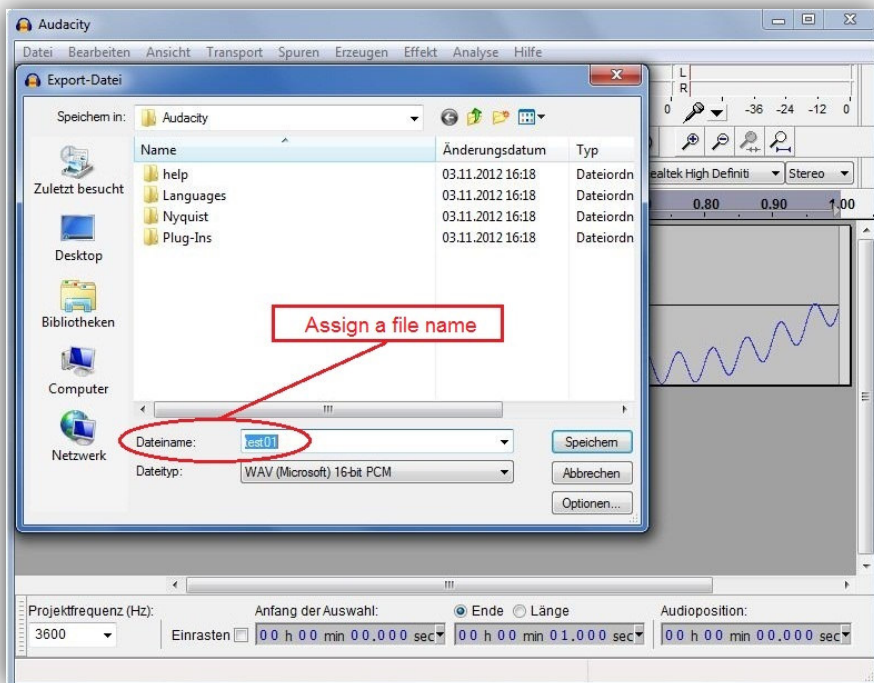

Completing the project

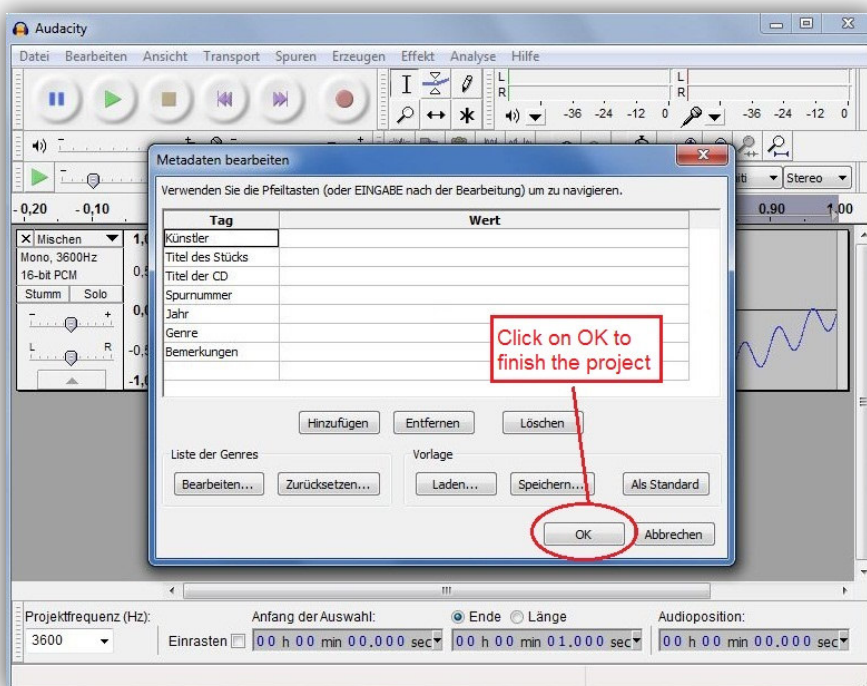

Further steps

The created file must be saved and copied to a MMC or SD memory card. The memory card must then be inserted to the EAC-S. To select the desired memory location (memory 1-3) the button **User Memory** must be pushed twice. Pushing the button **Save Recal** opens the file selection dialog where the desired .wav file may be selected by the rotary pulse encoder **Frequency/Select**. The file was saved and may be selected like a standard wave form by using the button **User Memory**.

19.1.5 Creating a .wav file with macros

Macros for a spreadsheet program can be easily created because the header of a wave file for the EAC-S can always be the same. The first 44 bytes always contain the following:

```
0000h: 52 49 46 46 44 1C 00 00 57 41 56 45 66 6D 74 20
0010h: 10 00 00 00 01 00 01 00 20 BF 02 00 40 7E 05 00
0020h: 02 00 10 00 64 61 74 61 20 1C 00 00 01 00 02 00
red: wave data
```

The wave files follow as 16 bit integer. The LSB is written first. In the example above the first two data sets are 0001h and 0002h. The following macros generate a wave file with a filename on position A1 and reference data on position A2 to A3601 of the spreadsheet. The data range is always 32767 to -32767.

Sample wave file

In principle, the output is programmed to the desired signal form/voltage and the off-gas voltage is changed as desired. In the example, no special WAV is needed because the signal curve is sinusoidal. The voltage dip can be generated either by script or with a PC+appropriate software. Of course, you have to pay attention to the right timing.

Here is an example as a script :

```
sine # output sine
ia 5 # output current 5A
frq 50 # output frequency 50Hz
run # enable output
loop # return
uac 230 # Output voltage 230V
wait # wait for keystroke
uac 185 # Output voltage 185V
delay 0.050 # wait 50ms
uac 230 # output voltage 230V, becomes active at next zero crossing
# Script now jumps to loop
```

(The command WAIT is only included from version V87 (9/2016))

If a special WAV is to be used, it must of course be loaded beforehand.

Example: Macro for an ODF spreadsheet document (*.ods)

(example tested with Open Office 2.4.1)

```
Sub EAC_S_Wave

Dim FileNr As Integer
Dim FileName As String
Dim HeaderData() As Integer
Dim Doc As Object
Dim Sheet As Object
Dim Cell As Object

'Initialisiere Header-Data
HeaderData = Array(&h4952,&h4646,&h1C44,&h0000,&h4157,&h4556,_
&h6D66,&h2074,&h0010,&h0000,&h0001,&h0001,&hFFFBBF20,&h0002,_
&h7E40,&h0005,&h0002,&h0010,&h6164,&h6174,&h1C20,&h0000)

Doc = StarDesktop.CurrentComponent
Sheet = Doc.Sheets(0)

Cell = Sheet.getCellByPosition(0, 0)
if(Cell.String = "") then
MsgBox("Please insert file name at pos A1 (without extension)")
Exit Sub
endif

'WAV-Datei öffnen
FileName = Cell.String+".WAV"
FileNr = Freefile
Open FileName For Random As #FileNr
Seek #FileNr,1

'Headerdaten schreiben
For i% = 0 To 21
x% = HeaderData(i%) 'Achtung! Variable nicht direkt zuweisen,
Put #FileNr,,x% 'da diese intern als Long behandelt wird!
Next i%

'Wavedaten schreiben
For i% = 1 To 3600
Cell = Sheet.getCellByPosition(0, i%)
x% = Cell.Value
Put #FileNr,,x%
Next i%
```

```
Close #FileNr
End Sub
```

Example: Macro for an Excel spreadsheet (.xls):*

```
Sub EAC_S_Wave()

Dim FileNr As Integer
Dim FileName As String
Dim HeaderData As Variant

'Initialisiere Header-Data
HeaderData = Array(&H4952, &H4646, &H1C44, &H0, &H4157, &H4556, _
&H6D66, &H2074, &H10, &H0, &H1, &H1, &HFFFFBF20, &H2, _
&H7E40, &H5, &H2, &H10, &H6164, &H6174, &H1C20, &H0)

If (Cells(1, 1).Value = "") Then
MsgBox ("Please insert file name at pos A1 (without extention)")
Exit Sub
End If

"WAV-Datei öffnen"
FileName = Worksheets("EAC_WAV").Cells(1, 1).Value + ".WAV"
FileNr = FreeFile
Open FileName For Random As #FileNr Len = 2
Seek #FileNr, 1

'Headerdaten schreiben
For i% = 0 To 21
x% = HeaderData(i%) 'Achtung! Variable nicht direkt zuweisen,
Put #FileNr, , x% 'da diese intern als Long behandelt wird!
Next i%

'Wavedaten schreiben
For i% = 2 To 3601
x% = Worksheets("EAC_WAV").Cells(i%, 1).Value
Put #FileNr, , x%
Next i%

Close #FileNr
End Sub
```

20 NOTES

